

INSTRUCTION MANUAL

TM-1740G Centre Lathe (415V) 430 x 1000mm - 78mm Bore

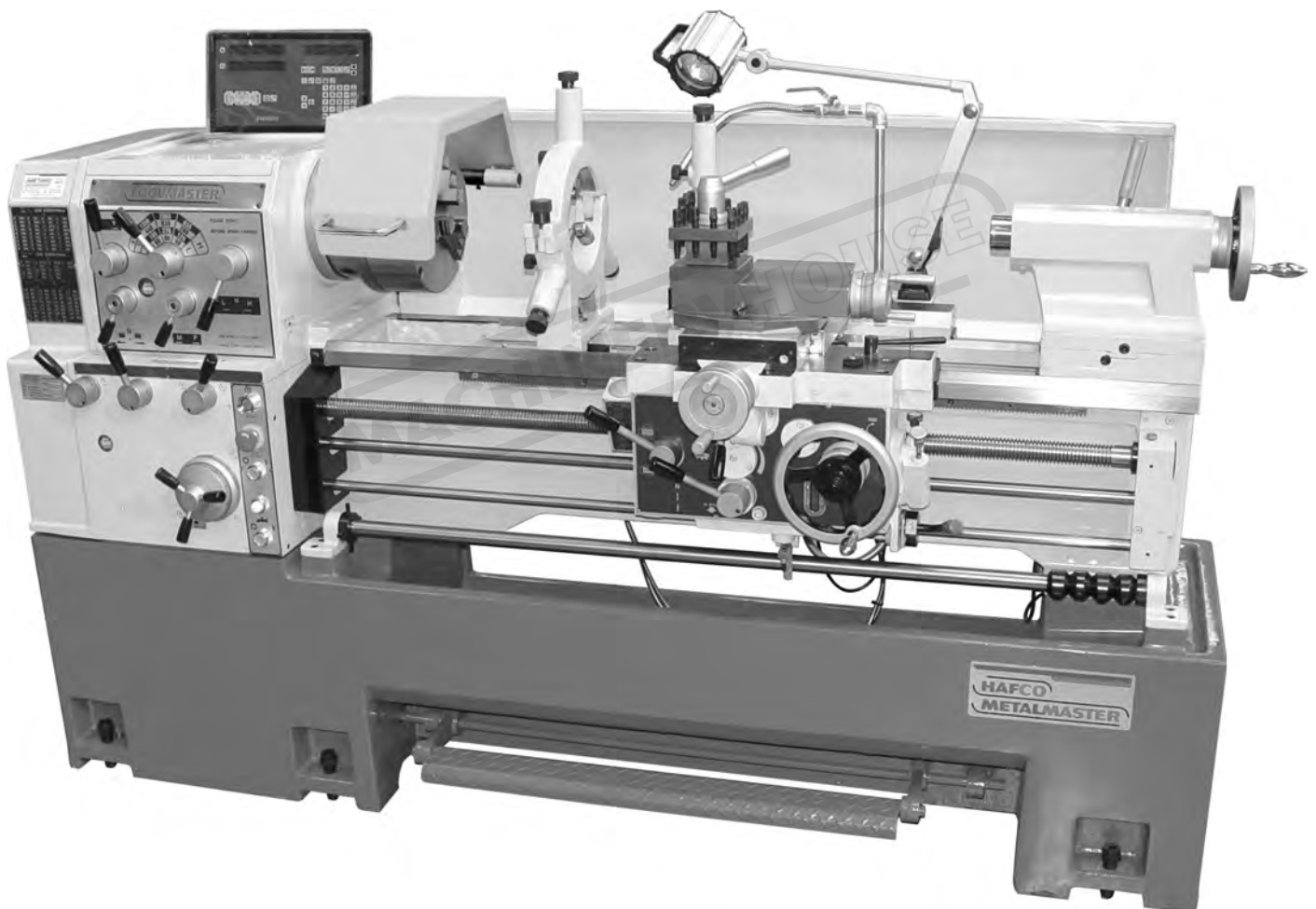

L632D

CONTENTS

PREFACE

1. WH HIGH SPEED PRECISION LATHE

1-1 Machine Assembly

2. ELECTRICAL CIRCUIT CONTROL

2-1 Electrical Wiring

2-2 Electrical Equipment

2-3 Electrical Cautions

2-4 Circuit Diagram

3. TESTING & OPERATION

3-1 Operation Symbols

3-2 Transmission & Stop of Spindle

3-3 Spindle Speed Selection

3-4 Intermittent Operation of Spindle

3-5 The Importance and Methods of Spindle Leveling Adjustment

3-6 Transmission & Stop of Gear Box

3-7 Gear Box Operation

3-8 Manual Operation

3-9 Automatic Feeding Operation

3-10 Automatic Feeding Stop Operation

3-11 4-position Automatic Feeding Stop Operation

3-12 Tailstock Operation

4. THREADING

- 4-1 Leadscrew Drive
- 4-2 Cutting Threads
- 4-3 Thread Dial Indicator
- 4-4 Thread & Feed Chart
- 4-5 Module & D.P. Thread Chart

5. LUBRICATION

- 5-1 Headstock Lubrication
- 5-2 Gear Box & Apron Lubrication
- 5-3 Lubrication Chart
- 5-4 Lubrication Location

6. MAINTENANCE & ADJUSTMENT

- 6-1 Headstock
- 6-2 Apron & Saddle
- 6-3 Gear Box
- 6-4 Tailstock Center Line Adjustment
- 6-5 Belt Tension Adjustment
- 6-6 Brake Belt Adjustment
- 6-7 Brake & Limit Switch Adjustment
- 6-8 Leadscrew Backlash Adjustment
- 6-9 Cutting Coolant Repair

APPENDIX: PART LIST

PREFACE

Thank you for adopting our lathe to be your producing tool. Before operating the lathe, it is necessary to study our manual. If operated correctly, the machine is efficient and easy-to-operate.

This manual consists of 7 chapters, mainly including operation, maintenance and list of spare parts. Please read the manual thoroughly from the first page to the last in order to be familiar with this machine, and work efficiently and accurately. Besides, based on safety consideration, the operator must be well trained according to all the instructions in the manual. Any damage of the machine and injure on the operator caused by mis-operation and disregard of our instruction is not under warranty.

In addition to the instructions listed in our manual, there are some matters needing attention as well:

1. Do not expose the machine outdoors in order to avoid any damage caused by the weather, besides, keep the machine away from cooling blower.
2. Lubricate the machine with recommended or appointed lubricant or grease.
3. Remove chips from time to time to keep the machine clean, this will make the machine live longer.
4. If the bedway is dented, do not move the carriage till the bedway is repaired.

If you have any question, please do not hesitate to contact Win Ho Technology Industrial Co., Ltd.

1. WH HIGH SPEED PRECISION LATHE

1-1 Machine Assembly

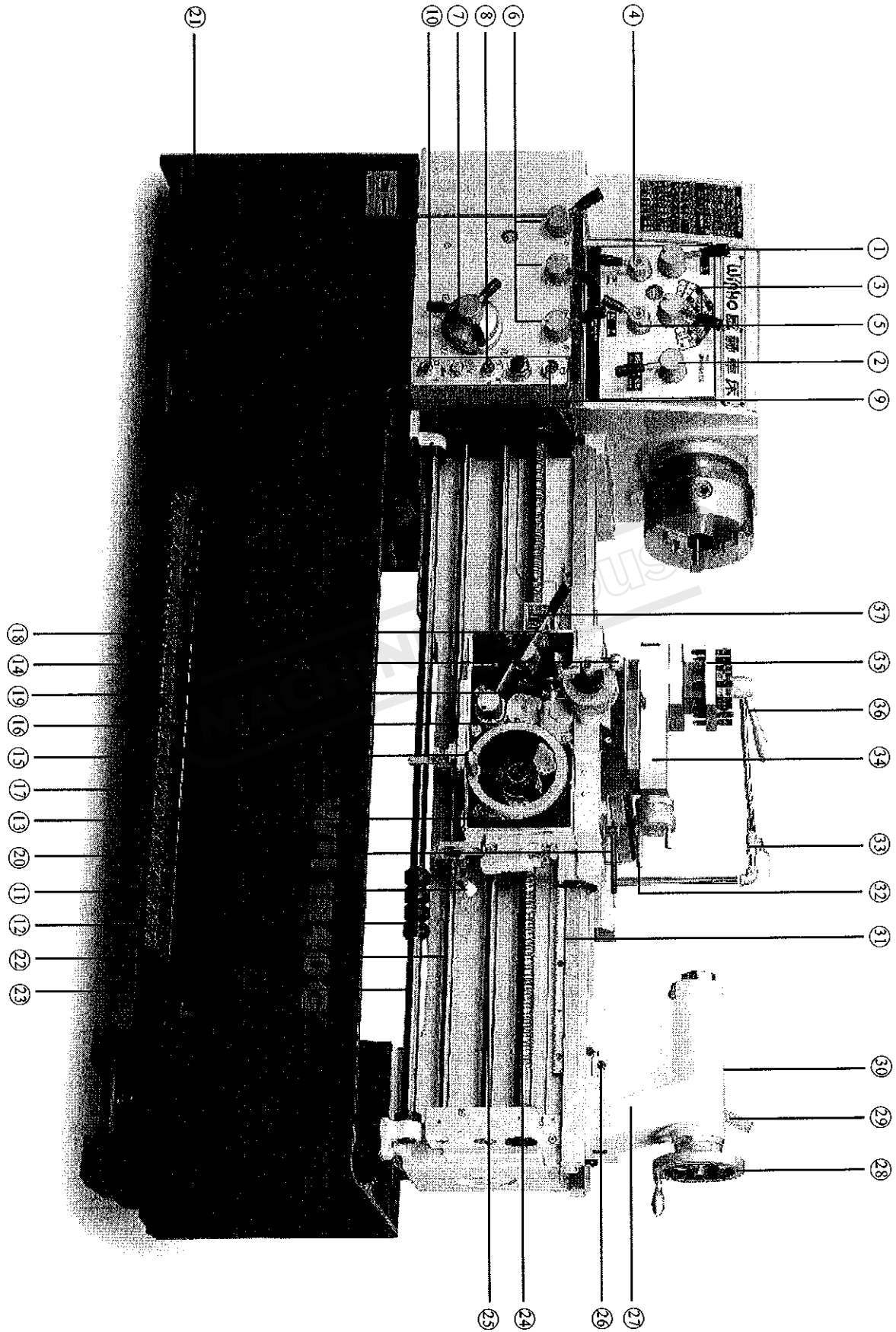

ITEM	DESCRIPTION	ITEM	DESCRIPTION
1	Spindle speed shifting lever	20	Carriage clamping lever
2	Spindle speed H/L shifting lever	21	Foundation adjusting bolt
3	Spindle speed shifting selection lever	22	Spindle operation control rod
4	Forward/Reverse Shifting lever	23	4 position automatic feed stop selection rod
5	Thread/Feed Selection lever	24	Leadscrew
6	Thread/Feed Shifting lever	25	Auto-feed rod
7	10-step feed selection dial	26	Tailstock set over adjusting Screw
8	Power source switch (Main switch)	27	Tailstock body
9	Intermittent button	28	Tailstock handwheel
10	Coolant supply button	29	Tailstock body Clamping lever
11	Spindle operation control lever	30	Tailstock spindle locking lever
12	Adjustable trip dog	31	Rack
13	Longitudinal feed hand wheel	32	Compound rest handle
14	Cross slide handle	33	Coolant control valve
15	Trip plunger	34	Compound rest
16	Auto feeding engaged lever	35	Four way tool post
17	Foot brake pedal	36	Tool post clamping lever
18	Half nut engaged lever	37	Thread dial indicator
19	Feed axis selector		

2. ELECTRICAL CIRCUIT CONTROL

2-1 Electrical Wiring

The electrical control box can be found by opening its cover at the back side of bed. Connect the power source wire with the connecting points (R.S.T)

The wire between the power source and the connecting points must be over sectional area 8mm^2 (5.5mm^2 for 460 or 18" series).

The main switch between machine and power source also should be equipped with safety fuse. Besides, the machine must have a earth wire.

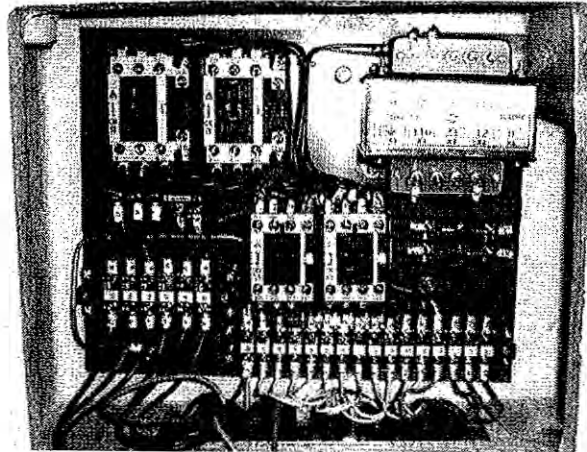

2-2 Electrical Equipment

1. The electrical control box is also equipped with overload circuit breaker and electric magnetic contactor to protect motor from burning out by overload.
2. The main switch is connected with micro switch.
3. The foot brake is connected with micro switch. Stepping the footbrake is quicker to stop the lathe than turning off the switch. The spindle can only revolute again by re-operating the spindle operation control lever after using the foot brake.
4. The spindle will rotate continuously as long as the intermittent switch on the top of the electrical panel is pressed.

2-3 Electrical Cautions

After wiring, check the rotation of the spindle of the spindle. Turn the main switch "ON" and make sure the safety of spindle. Then push intermittent button (T) momentarily. The correction direction of the spindle rotation is counter clockwise. (looking from tailstock for a downward movement of the spindle operation control lever.) Wrong direction of rotation can be rectified by interchanging any two of the three phase lines (R.S.T.) in the power source.



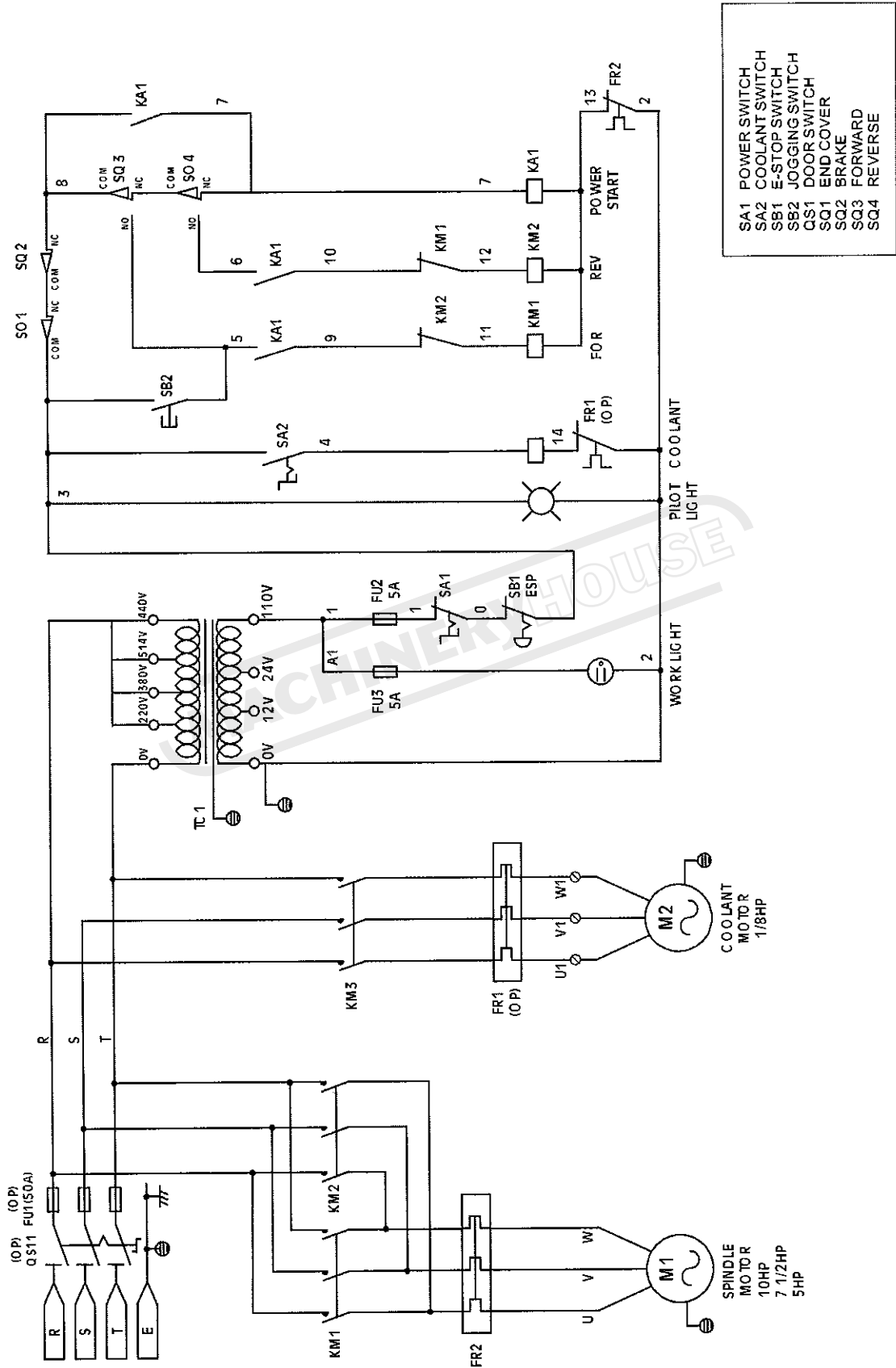







2-4 Circuit Diagram

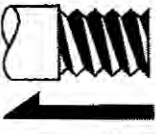
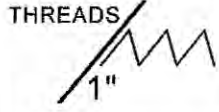

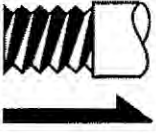
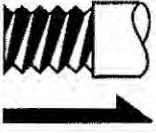
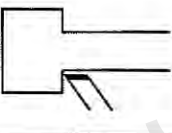
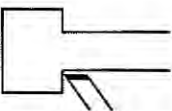
- SA1 POWER SWITCH
- SA2 COOLANT SWITCH
- SB1 E-STOP SWITCH
- SB2 JOGGING SWITCH
- SQ1 DOOR SWITCH
- SQ2 END COVER
- SQ3 BRAKE
- SQ4 FORWARD
- SQ3 FORWARD
- SQ4 REVERSE

3. TESTING & OPERATION

3-1 Operation Symbols

1	HIGH	High speed revolution	11		Variable adjustment (pressure) Clockwise: pressure increase Counterclockwise: pressure decrease
2	LOW	Low speed Revolution	12		Electrical control box
3		Forward revolution	13		Imperial threads
4	N	Neutral gear	14		Metric threads
5		Reverse revolution	15		Auto feeding Rate per revolution
6		Feeding	16		Pump
7		Intermittent button	17		Power switch-ON
8		Cross feeding	18		Power switch-OFF
9		Longitudinal feeding	19	OIL	Oil inlet (hole)
10		Cone clutch			

3-2 Transmission & Stop of Spindle

After the procedure described previously in this manual have been done, it is time to test the machine.

Position the spindle speed H/L shifting lever #2 to "L", the spindle speed shifting selection lever #3 to the very left side, and forward/reverse shifting lever #4 to "N" position. Lift the spindle operation control lever (#11 of item 1-1), the spindle will rotate forward, press down the lever, the spindle will rotate reverse; in 'Neutral' position, the spindle will stop. For normal forward & reverse revolution, always operate the spindle operation control lever. For emergency stop, step on the foot brake, the spindle operation control lever should push back to 'Neutral' position after stepping the foot brake. Afterward, start the spindle.

Turn the coolant supply button (#10 of item 1-1). Adjust the adjusting valve for the required coolant flow.

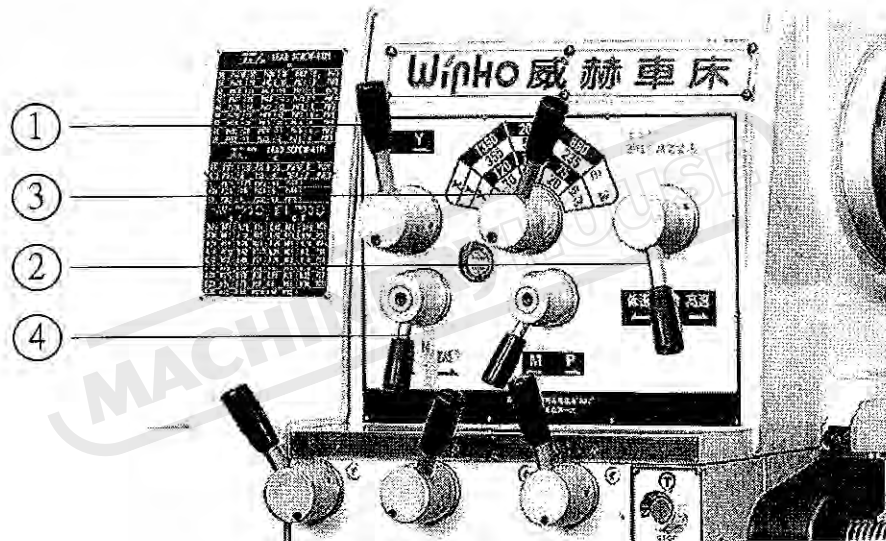

3-3 Spindle Speed Selection

Spindle speed shift is made up of three speed shifting levers:

1. Spindle speed shifting lever
2. Spindle speed H/L shifting lever
3. Spindle speed shifting selection lever for total of 12 spindle speed numbers

Put the spindle speed H/L shifting lever to 'neutral' gear between 'H' and 'L' rotate the spindle by hand.

For safety and protecting the gears from damage, only change speeds when the motor is completely stopped. If the gears are not easily engaged, press intermittent button and handle the speed shifting levers to change the speeds.

Caution: Do not shift gears while spindle is turning. Be certain gears are properly engaged before starting.

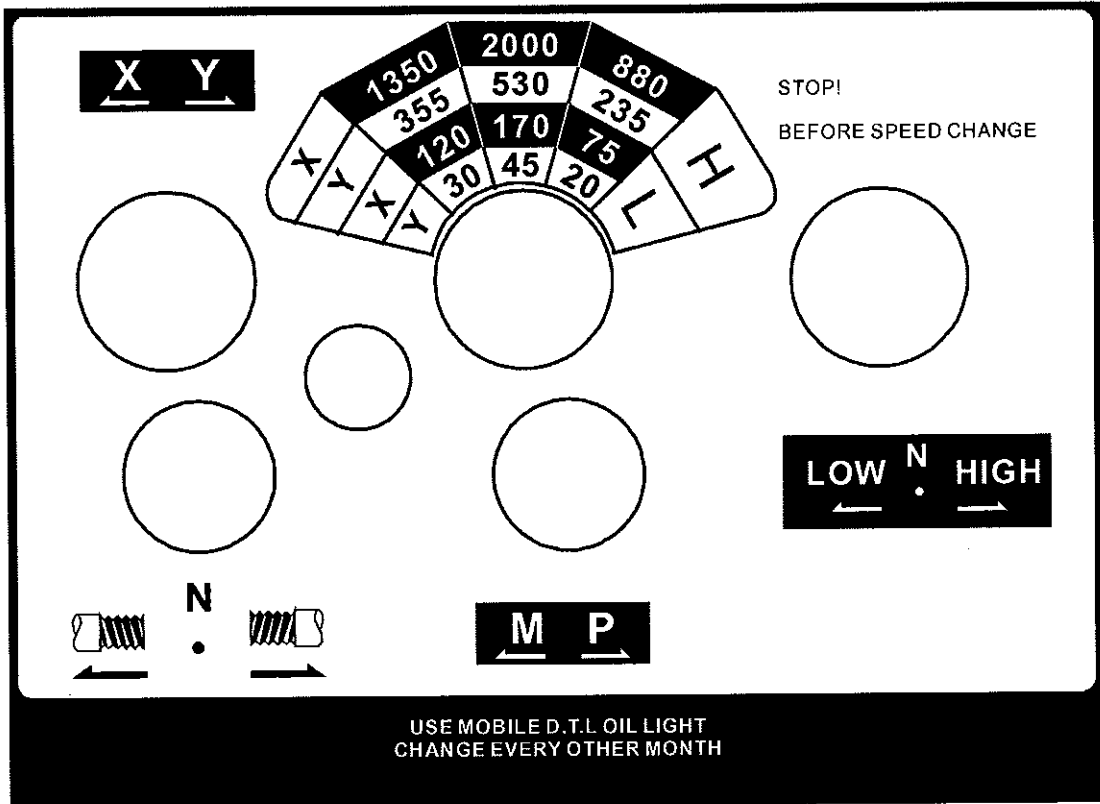

3-4 Intermittent (Inching) Operation of Spindle

For the convenience of spindle speed shifting, feeding rate recognition and work piece center line and adjustment, press the intermittent button #9 located on the right side of the gear box, and the spindle will rotate forward. The spindle will rotate as long as the intermittent switch is pressed. The intermittent switch cannot rotate reverse.

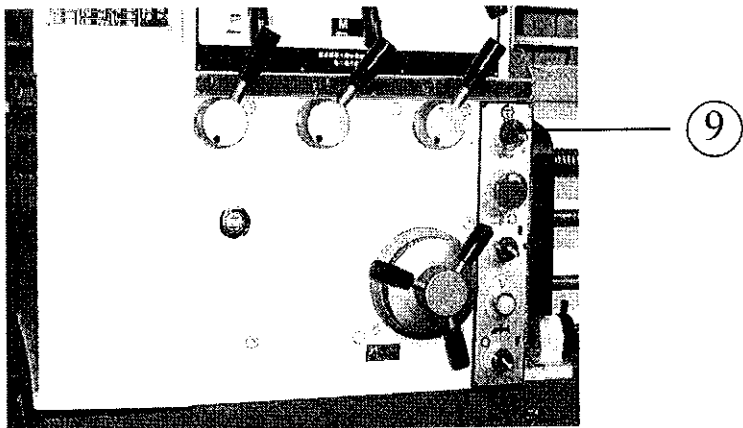

3-5 The Importance and Methods of Spindle Leveling Adjustment

1. A lathe without proper leveling adjustment is likely to chatter. As a consequence, this will influence the cutting accuracy of work piece and result in poor roundness accuracy and finish. It is necessary to pay attention to the spindle leveling from time to time in order to have the best cutting condition of the lathe. Belt, 3-jaw chuck and the accumulative tolerances of parts on headstock, all such factors, can make the lathe chatter. To get rid of those problems, our lathe is especially designed to be equipped with leveling blocks mounted on the locking nut at the rear side of the spindle. The leveling blocks can be properly adjusted according to different condition. Please refer to following description & figure for proper adjustment.
2. Firstly, set up the spindle speed at 1350 rpm. Put the palm on left hand of the headstock cover and press the switch by left hand. Then switch on the lathe to make the spindle turn. Move the leveling block "A & C" left or right by hand feeling until obtain the best leveling position. Then also move the leveling block "B" left or right till the best position with same way. Adjust repeatedly till your hand feels no chattering. Afterwards, change the spindle speed to 2000rpm or 880rpm and check the leveling in the same way as we did at 1350rpm. Finally, for the leveling block set screw a, a', b, b. c.c. securely.

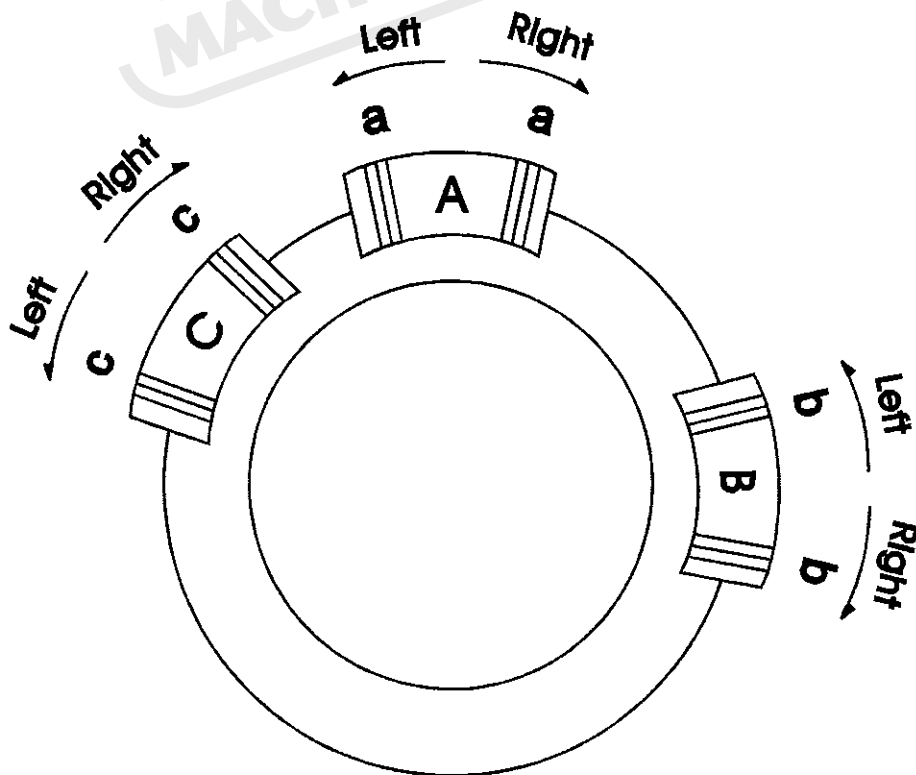

3-6 Transmission & Stop of Gear Box

Open the end cover to find the gear train transmitting from headstock to gear box, position the forward/reverse shifting lever (#4 of item 1-1) to right side, the spindle will rotate forward; to right; reverse; to Neutral, stop. Do not change the gears while turning.

3-7 Gear Box Operation

1. Threading:

With the special design, there is no need to re-arrange the back gears for threading. Please refer to the 'threading & feeding table' and handle the thread/feed selection lever (#5 of item 1-1), thread, feed shifting lever (#6 of item 1-1) and 10-step feed selection dial (#7 of item 1-1) accordingly.

2. Auto feeding

Also select the appropriate auto feeding rate by positioning the thread, feed selection lever ((#5 of item 1-1), thread, feed shifting lever (#6 of item 1-1) and 10-step feed selection dial (#7 of item 1-1) as indicated on the 'threading and feeding table'.

3-8 Manual Operation

First, position both the halt nut engage lever #18, and forward and reverse shifting lever (#4 of item 1-1) to 'N' position to operate the apron handwheel #13 cross slide handle #14, and compound rest handle #32 easily.

It feeds 17mm per revolution of apron handwheel. The dials on cross slide and compound rest is graduated 0.02mm per calibration, and feeds 4mm per revolution.

The tool post can be rotated clockwise after loosening the tool post clamping lever (#36 of item 1-1). Then position and tighten the clamping lever. For fixing the apron, just handle the saddle clamping lever #20. For cross slide and compound rest, screw tightly the set screws beside the taper pin.

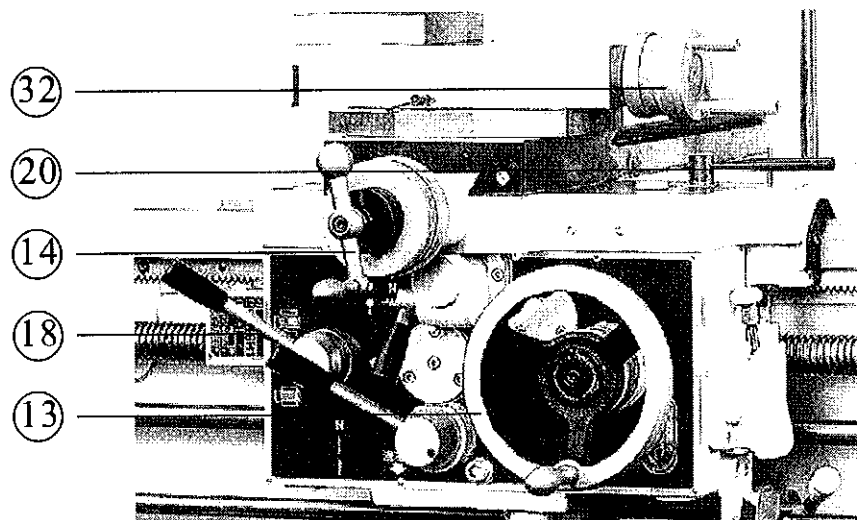

3-9 Automatic Feeding Operation

- (1) Position the thread/reverse shifting lever (#4 of item 1-1) for obtaining the required feeding position.
- (2) Shift the thread, feed selection lever (#5 of item 1-1), thread, feed selection lever (#6 of item 1-1), 10-step feed selection lever to select the appropriate feeding rate.
- (3) For threading, push the half nut engaged lever (#18 of item 1-1) downward till fully engaged.
- (4) For cross feeding, push the feed axis selector (#19 of item 1-1) downward till full engaged.
- (5) For longitudinal feeding, pull the feed axis selector.

3-10 Automatic Feeding Stop Operation

The apron is equipped with automatic stop device. Tighten the screw on the top of the adjustable trip dog #12, and then fix it to the required position. Be careful that the top tip of the adjustable trip dog can be set onto the required position for forward and backward feeding. To avoid danger or damage to work piece, always have a test before starting.

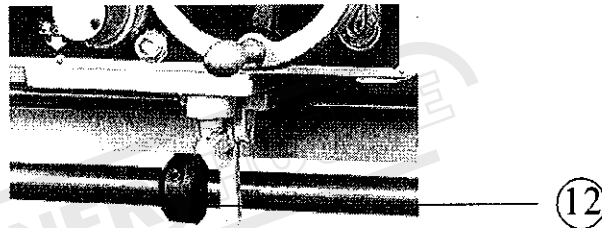

3-11 4-position Automatic Feeding Stop Operation

To process certain length or step type of work piece, can use the 4-position Automatic feeding stop for length set cutting.

- (1) Rotate the adjustable trip dog (#12 of item 1-1) to the required setting position and make the top tip of the adjustable trip dog face outward. Try to test the auto feeding and adjust the front and back position of the adjustable trip dog if required, in order to ascertain the position setting accuracy.
- (2) Secondly, operate the 4-position automatic feed stop selection lever to the second adjustable trip dog by hand and fix the adjustable trip dog according to above procedure.
- (3) Same procedure for the third and fourth adjustable trip dog.
- (4) While the apron is auto-feeding, only the top tip of adjustable trip dog, which faces outward can touch the trip plunger (#15 of item 1-1). After stopping the auto feeding of apron, the other three adjustable trip dog can pass freely without any function.

3-12 Tailstock Operation

- (1) The tailstock handwheel dial is divided 0.02mm per graduation. The tailstock moves forward 5mm per clockwise revolution of handwheel. When revolving clockwise, the quill will retract and , to the last, the center will release automatically.
- (2) Push the tailstock quill locking lever #30 forward to fix the tailstock quill. For fixing the tailstock onto the bedway, push tailstock body clamping lever #29 forward.
- (3) Adjust the centerline of the tailstock by loosening the tailstock set-over adjusting screw #26 on the side firstly, then adjust the screw on the other side. After adjustment, tighten the screw on both sides.

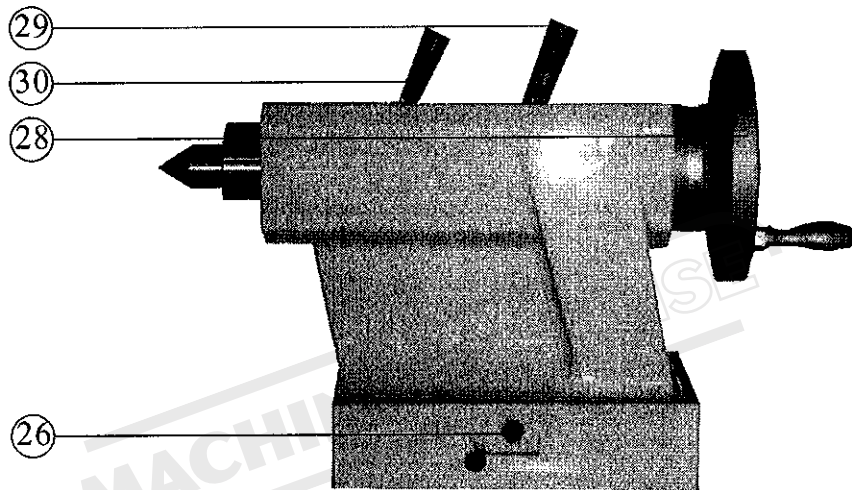

4. Threading

4-1 Leadscrew Drive

Move the forward/reverse lever (#4 of item 1-1) to the right will cause the leadscrew to rotate backwards, moving the lever to the left the leadscrew will rotate forward and when lever is in neutral the leadscrew will stop.

4-2 Threading

1. After selecting the thread to be cut, set the following levers to the appropriate position: #5, #6 & #7 of item 1-1. (Example 18 t.p.i. PAE2)
2. Turn off the lathe.
3. Engage the half nut by pushing #18 of item 1-1 down, making sure it is fully engaged.

4-3 Thread Dial Indicator

1. Thread dial indicator for Imperial leadscrew

To cut even number threads the leadscrew can be engaged on any number of line. For odd number threads the leadscrew can be engaged on any number. Fractional threads (1/2, 1/4 etc.) leadscrew can only be engaged on the same number or line.

Note: When cutting metric threads on a lathe with an Imperial leadscrew be sure the half nut is engaged at all times (If not the thread will not repeat).

2. Thread dial indicator for Metric leadscrew cutting metric threads

There are two dials, 2&7 division and 3&5 division for Metric leadscrew while using Metric thread dial indicator. Use 3&5 division dial for cutting pitches 1.25, 2.5, 5.0, 2.25, 4.5; for the rest threads, use 2&7 division dial.



Example1: For cutting pitches 0.5, 0.75, 1.0, 1.5, 2.0, 3.0, 4.0, 6.0, use 14T worm gear and 2&7 division dial. The dial numbers at which the leadscrew nuts may be engaged are 7; that is, every division can be engaged by leadscrew nuts.

Example2: For cutting pitches 1.75, 3.5, 7.0 also use the same 14T worm gear and 2&7 division dial. But the dial numbers at which the leadscrew may be engaged on 2; number 1 and 2.

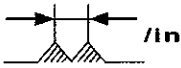

Gear teeth	Pitch		Dial division	Half nuts engaged number
11T	2.75	5.5	2	1
13T	3.25	6.5	2	1
14T	1.75	3.5	2	1,2
	7			
	0.5	0.75	7	1,2,3 4,5,6 7
	1	1.5		
2	3			
15T	4	6		
	1.25	2.5	3	1,2,3
	5			
	2.25	4.5	5	1,2,3
18T	6.75		2	1,2

4-4 Thread & Feed Chart

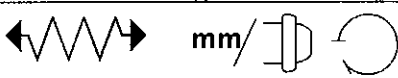
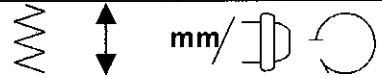

For Swing 17", 19", 20" (430mm, 480mm, 510mm) Series while Metric Leadscrew & Metric Feed

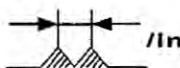
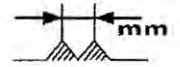
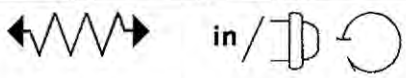
 LEAD SCREW-P=6mm R							
56	PAD10	32	PAD1	18	PAE2	9 1/2	PAF3
54	PAD9	28	PAE10	16	PAE1	9	PAF2
52	PAD8	27	PAE9	14	PAF10	8	PAF1
48	PAD7	26	PAE8	13 1/2	PAF9	7	PBF10
46	PAD6	24	PAE7	13	PAF8	6	PBF7
44	PAD5	23	PAE6	12	PAF7	5 1/2	PBF5
40	PAD4	22	PAE5	11 1/2	PAF6	5	PBF4
38	PAD3	20	PAE4	11	PAF5	4 1/2	PBF2
36	PAD2	19	PAE3	10	PAF4	4	PBF1
 LEAD SCREW-P=6mm C							
0.5	PSF1	1.75	PSE10	3.5	PSD10	6	PUD7
0.75	PSF7	2	PSD1	4	PUD1	7	PUD10
1	PSE1	2.25	PSD2	4.5	PUD2		
1.25	PSE4	2.5	PSD4	5	PUD4		
1.5	PSE7	3	PSD7	5.5	PUD5		
 C.T.				 C.T.			
0.05	MF1	0.30	MD4	0.02	MF1	0.15	MD5
0.06	MF2	0.34	MD5	0.03	MF3	0.17	MD7
0.08	MF5	0.37	MD7	0.04	MF7	0.20	MD10
0.10	MF10	0.42	MD10	0.05	ME1	0.24	PD2
0.13	ME2	0.48	PD1	0.06	ME3	0.27	PD4
0.17	ME5	0.54	PD2	0.07	ME5	0.30	PD5
0.21	ME10	0.60	PD4	0.08	ME7	0.34	PD7
0.24	MD1	0.74	PD7	0.1	MD1	0.40	PD10
0.27	MD2	0.82	PD10	0.12	MD2		

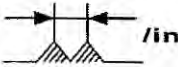
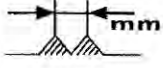

For Swing 17", 19", 20" (430mm, 480mm, 510mm) Series while Imperial Leadscrew & Imperial Feed

 LEAD SCREW - 4TPI							
R							
56	PAD10	32	PAD1	18	PAE2	9 1/2	PAF3
54	PAD9	28	PAE10	16	PAE1	9	PAF2
52	PAD8	27	PAE9	14	PAF10	8	PAF1
48	PAD7	26	PAE8	13 1/2	PAF9	7	PBF10
46	PAD6	24	PAE7	13	PAF8	6	PBF7
44	PAD5	23	PAE6	12	PAF7	5 1/2	PBF5
40	PAD4	22	PAE5	11 1/2	PAF6	5	PBF4
38	PAD3	20	PAE4	11	PAF5	4 1/2	PBF2
36	PAD2	19	PAE3	10	PAF4	4	PBF1
 LEAD SCREW-P - 4TPI							
C							
0.5	PSF1	1.75	PSE10	3.5	PSD10	6	PUD7
0.75	PSF7	2	PSD1	4	PUD1	7	PUD10
1	PSE1	2.25	PSD2	4.5	PUD2		
1.25	PSE4	2.5	PSD4	5	PUD4		
1.5	PSE7	3	PSD7	5.5	PUD5		
 C.T.				 C.T.			
0.002	MF1	0.001	MD4	0.001	MF7	0.0043	MD8
0.0025	MF2	0.012	MD5	0.0012	MF10	0.0047	MD10
0.0031	MF5	0.014	MD7	0.0015	ME2	0.0052	PD1
0.0039	MF10	0.016	MD10	0.0017	ME4	0.0060	PD2
0.0051	ME2	0.018	PD1	0.002	ME7	0.0071	PD5
0.006	ME5	0.020	PD2	0.0023	ME10	0.0078	PD7
0.008	ME10	0.023	PD4	0.0026	MD1	0.0086	PD8
0.009	MD1	0.027	PD7	0.0030	MD2	0.0094	PD10
0.010	MD2	0.032	PD10	0.0036	MD5		

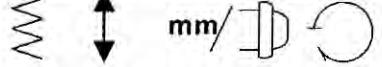

For Swing 17", 19", 20" (430mm, 480mm, 510mm) Series while Imperial Leadscrew but Metric Feed

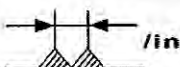
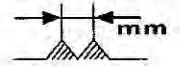
 LEAD SCREW – 4TPI R							
56	PAD10	32	PAD1	18	PAE2	9 1/2	PAF3
54	PAD9	28	PAE10	16	PAE1	9	PAF2
52	PAD8	27	PAE9	14	PAF10	8	PAF1
48	PAD7	26	PAE8	13 1/2	PAF9	7	PBF10
46	PAD6	24	PAE7	13	PAF8	6	PBF7
44	PAD5	23	PAE6	12	PAF7	5 1/2	PBF5
40	PAD4	22	PAE5	11 1/2	PAF6	5	PBF4
38	PAD3	20	PAE4	11	PAF5	4 1/2	PBF2
36	PAD2	19	PAE3	10	PAF4	4	PBF1
 LEAD SCREW – 4TPI C							
0.5	PSF1	1.75	PSE10	3.5	PSD10	6	PUD7
0.75	PSF7	2	PSD1	4	PUD1	7	PUD10
1	PSE1	2.25	PSD2	4.5	PUD2		
1.25	PSE4	2.5	PSD4	5	PUD4		
1.5	PSE7	3	PSD7	5.5	PUD5		
 C.T.				 C.T.			
0.05	MF1	0.29	MD4	0.02	MF1	0.14	MD5
0.06	MF2	0.32	MD5	0.03	MF3	0.16	MD7
0.08	MF5	0.35	MD7	0.04	MF7	0.18	MD10
0.10	MF10	0.40	MD10	0.05	ME1	0.2	PD1
0.13	ME2	0.45	PD1	0.06	ME3	0.24	PD2
0.16	ME5	0.52	PD2	0.07	ME5	0.28	PD5
0.20	ME10	0.58	PD4	0.08	ME7	0.32	PD7
0.23	MD1	0.70	PD7	0.1	MD1	0.36	PD10
0.26	MD2	0.80	PD10	0.12	MD2		

For Swing 22", 26" (560mm, 660mm) Series while Metric Leadscrew & Metric Feed

 LEAD SCREW-P=6mm							
R							
56	KAD10	27	KAE9	13	KAF8	5	KBF4
54	KAD9	26	KAE8	12	KAF7	4 1/2	KBF2
52	KAD8	24	KAE7	11 1/2	KAF6	4	KBF1
48	KAD7	23	KAE6	11	KAF5	3 1/2	JBF10
46	KAD6	22	KAE5	10	KAF4	3 1/4	JBF8
44	KAD5	20	KAE4	9 1/2	KAF3	3	JBF7
40	KAD4	19	KAE3	9	KAF2	2 7/8	JBF6
38	KAD3	18	KAE2	8	KAF1	2 3/4	JBF5
36	KAD2	16	KAE1	7	KBF10	2 1/2	JBF4
32	KAD1	14	KAF10	6	KBF7	2 1/4	JBF2
28	KAE10	13 1/2	KAF9	5 1/2	KBF5	2	JBF1
 LEAD SCREW-P=6mm							
C							
0.5	KSF1	2	KSD1	4.5	KUD2	9	JUD2
0.75	KSF7	2.25	KSD2	5	KUD4	10	JUD4
1	KSE1	2.5	KSD4	5.5	KUD5	11	JUD5
1.25	KSE4	3	KSD7	6	KUD7	12	JUD7
1.5	KSE7	3.5	KSD10	7	KUD10	13	JUD8
1.75	KSE10	4	KUD1	8	JUD1	14	JUD10
 mm/				 mm/			
C.T.				C.T.			
0.05	KF1	0.30	KD4	0.02	KF1	0.15	KD5
0.06	KF2	0.34	KD5	0.03	KF3	0.17	KD7
0.08	KF5	0.37	KD7	0.04	KF7	0.20	KD10
0.10	KF10	0.42	KD10	0.05	KE1	0.24	JD2
0.13	KE2	0.48	JD1	0.06	KE3	0.27	JD4
0.17	KE5	0.54	JD2	0.07	KE5	0.30	JD5
0.21	KE10	0.60	JD4	0.08	KE7	0.34	JD7
0.24	KD1	0.74	JD7	0.1	KD1	0.40	JD10
0.27	KD2	0.82	JD10	0.12	KD2		

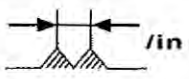
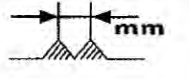
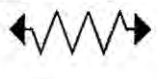
For Swing 22", 26" (560mm, 660mm) Series while Imperial Leadscrew & Imperial Feed

				LEAD SCREW - 4TPI			
				R			
56	KAD10	27	KAE9	13	KAF8	5	KBF4
54	KAD9	26	KAE8	12	KAF7	4 1/2	KBF2
52	KAD8	24	KAE7	11 1/2	KAF6	4	KBF1
48	KAD7	23	KAE6	11	KAF5	3 1/2	JBF10
46	KAD6	22	KAE5	10	KAF4	3 1/4	JBF8
44	KAD5	20	KAE4	9 1/2	KAF3	3	JBF7
40	KAD4	19	KAE3	9	KAF2	2 7/8	JBF6
38	KAD3	18	KAE2	8	KAF1	2 3/4	JBF5
36	KAD2	16	KAE1	7	KBF10	2 1/2	JBF4
32	KAD1	14	KAF10	6	KBF7	2 1/4	JBF2
28	KAE10	13 1/2	KAF9	5 1/2	KBF5	2	JBF1
				LEAD SCREW - 4TPI			
				C			
0.5	KSF1	2	KSD1	4.5	KUD2	9	JUD2
0.75	KSF7	2.25	KSD2	5	KUD4	10	JUD4
1	KSE1	2.5	KSD4	5.5	KUD5	11	JUD5
1.25	KSE4	3	KSD7	6	KUD7	12	JUD7
1.5	KSE7	3.5	KSD10	7	KUD10	13	JUD8
1.75	KSE10	4	KUD1	8	JUD1	14	JUD10
							
C.T.				C.T.			
0.002	KF1	0.011	KD4	0.001	KF7	0.0043	KD8
0.0025	KF2	0.012	KD5	0.0012	KF10	0.0047	KD10
0.0031	KF5	0.014	KD7	0.0015	KE2	0.0052	JD1
0.0039	KF10	0.016	KD10	0.0017	KE4	0.0060	JD2
0.0051	KE2	0.018	JD1	0.002	KE7	0.0071	JD5
0.006	KE5	0.020	JD2	0.0023	KE10	0.0078	JD7
0.008	KE10	0.023	JD4	0.0026	KD1	0.0086	JD8
0.009	KD1	0.027	JD7	0.0030	KD2	0.0094	JD10
0.010	KD2	0.032	JD10	0.0036	KD5		

For Swing 22", 26" (560mm, 660mm) Series while Imperial Leadscrew but Metric Feed

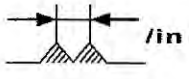
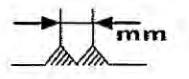
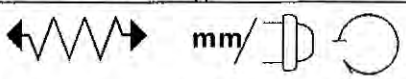
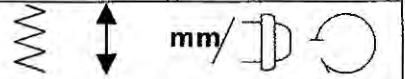
				LEAD SCREW – 4TPI			
				R			
56	KAD10	27	KAE9	13	KAF8	5	KBF4
54	KAD9	26	KAE8	12	KAF7	4 1/2	KBF2
52	KAD8	24	KAE7	11 1/2	KAF6	4	KBF1
48	KAD7	23	KAE6	11	KAF5	3 1/2	JBF10
46	KAD6	22	KAE5	10	KAF4	3 1/4	JBF8
44	KAD5	20	KAE4	9 1/2	KAF3	3	JBF7
40	KAD4	19	KAE3	9	KAF2	2 7/8	JBF6
38	KAD3	18	KAE2	8	KAF1	2 3/4	JBF5
36	KAD2	16	KAE1	7	KBF10	2 1/2	JBF4
32	KAD1	14	KAF10	6	KBF7	2 1/4	JBF2
28	KAE10	13 1/2	KAF9	5 1/2	KBF5	2	JBF1
				LEAD SCREW – 4TPI			
				C			
0.5	KSF1	2	KSD1	4.5	KUD2	9	JUD2
0.75	KSF7	2.25	KSD2	5	KUD4	10	JUD4
1	KSE1	2.5	KSD4	5.5	KUD5	11	JUD5
1.25	KSE4	3	KSD7	6	KUD7	12	JUD7
1.5	KSE7	3.5	KSD10	7	KUD10	13	JUD8
1.75	KSE10	4	KUD1	8	JUD1	14	JUD10
							
C.T.				C.T.			
0.05	KF1	0.29	KD4	0.02	KF1	0.14	KD5
0.06	KF2	0.32	KD5	0.03	KF3	0.16	KD7
0.08	KF5	0.35	KD7	0.04	KF7	0.18	KD10
0.10	KF10	0.40	KD10	0.05	KE1	0.20	JD1
0.13	KE2	0.45	JD1	0.06	KE3	0.24	JD2
0.16	KE5	0.52	JD2	0.07	KE5	0.28	JD5
0.20	KE10	0.58	JD4	0.08	KE7	0.32	JD7
0.23	KD1	0.70	JD7	0.1	KD1	0.36	JD10
0.26	KD2	0.80	JD10	0.12	KD2		

4-5 Module & D.P Thread Chart

For Swing 17", 19", 20" (430mm, 480mm, 510mm) Series while Metric Leadscrew

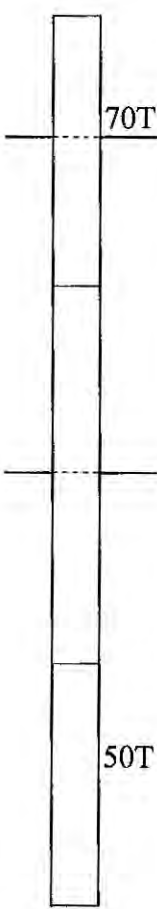
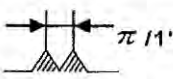
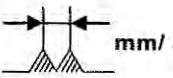
 <p>70T</p> <p>50T</p>	<div style="text-align: center;">  <p>LEAD SCREW-P=6mm</p> <p>R</p> </div>							
	56	PAD10	32	PAD1	18	PAE2	9 1/2	PAF3
	54	PAD9	28	PAE10	16	PAE1	9	PAF2
	52	PAD8	27	PAE9	14	PAF10	8	PAF1
	48	PAD7	26	PAE8	13 1/2	PAF9	7	PBF10
	46	PAD6	24	PAE7	13	PAF8	6	PBF7
	44	PAD5	23	PAE6	12	PAF7	5 1/2	PBF5
	40	PAD4	22	PAE5	11 1/2	PAF6	5	PBF4
	38	PAD3	20	PAE4	11	PAF5	4 1/2	PBF2
	36	PAD2	19	PAE3	10	PAF4	4	PBF1
<div style="text-align: center;">  <p>LEAD SCREW-P=6mm</p> <p>C</p> </div>								
0.5	PSF1	1.75	PSE10	3.5	PSD10	6	PUD7	
0.75	PSF7	2	PSD1	4	PUD1	7	PUD10	
1	PSE1	2.25	PSD2	4.5	PUD2			
1.25	PSE4	2.5	PSD4	5	PUD4			
1.5	PSE7	3	PSD7	5.5	PUD5			

For Swing 17", 19", 20" (430mm, 480mm, 510mm) Series while Imperial Leadscrew

	LEAD SCREW – 4TPI								
	R								
	56	PAD10	32	PAD1	18	PAE2	9 1/2	PAF3	
	54	PAD9	28	PAE10	16	PAE1	9	PAF2	
	52	PAD8	27	PAE9	14	PAF10	8	PAF1	
	48	PAD7	26	PAE8	13 1/2	PAF9	7	PBF10	
	46	PAD6	24	PAE7	13	PAF8	6	PBF7	
	44	PAD5	23	PAE6	12	PAF7	5 1/2	PBF5	
	40	PAD4	22	PAE5	11 1/2	PAF6	5	PBF4	
38	PAD3	20	PAE4	11	PAF5	4 1/2	PBF2		
36	PAD2	19	PAE3	10	PAF4	4	PBF1		
	LEAD SCREW – 4TPI								
	C								
0.5	PSE1	1.75	PSE10	3.5	PSD10	6	PUD7		
0.75	PSF7	2	PSD1	4	PUD1	7	PUD10		
1	PSE1	2.25	PSD2	4.5	PUD2				
1.25	PSE4	2.5	PSD4	5	PUD4				
1.5	PSE7	3	PSD7	5.5	PUD5				

For Swing 22", 26" (560mm, 660mm) Series while Metric Leadscrew

	LEAD SCREW-P=6mm R							
	56	KAD10	27	KAE9	13	KAF8	5	KBF4
	54	KAD9	26	KAE8	12	KAF7	4 1/2	KBF2
	52	KAD8	24	KAE7	11 1/2	KAF6	4	KBF1
	48	KAD7	23	KAE6	11	KAF5	3 1/2	JBF10
	46	KAD6	22	KAE5	10	KAF4	3 1/4	JBF8
	44	KAD5	20	KAE4	9 1/2	KAF3	3	JBF7
	40	KAD4	19	KAE3	9	KAF2	2 7/8	JBF6
	38	KAD3	18	KAE2	8	KAF1	2 3/4	JBF5
	36	KAD2	16	KAE1	7	KBF10	2 1/2	JBF4
	32	KAD1	14	KAF10	6	KBF7	2 1/4	JBF2
	28	KAE10	13 1/2	KAF9	5 1/2	KBF5	2	JBF1
	LEAD SCREW-P=6mm C							
	0.5	KSF1	2	KSD1	4.5	KUD2	9	JUD2
	0.75	KSF7	2.25	KSD2	5	KUD4	10	JUD4
	1	KSE1	2.5	KSD4	5.5	KUD5	11	JUD5
	1.25	KSE4	3	KSD7	6	KUD7	12	JUD7
	1.5	KSE7	3.5	KSD10	7	KUD10	13	JUD8
1.75	KSE10	4	KUD1	8	JUD1	14	JUD10	

For Swing 22", 26" (560mm, 660mm) Series while Imperial Leadscrew

	LEAD SCREW – 4TPI							
	R							
	56	KAD10	27	KAE9	13	KAF8	5	KBF4
	54	KAD9	26	KAE8	12	KAF7	4 1/2	KBF2
	52	KAD8	24	KAE7	11 1/2	KAF6	4	KBF1
	48	KAD7	23	KAE6	11	KAF5	3 1/2	JBF10
	46	KAD6	22	KAE5	10	KAF4	3 1/4	JBF8
	44	KAD5	20	KAE4	9 1/2	KAF3	3	JBF7
	40	KAD4	19	KAE3	9	KAF2	2 7/8	JBF6
	38	KAD3	18	KAE2	8	KAF1	2 3/4	JBF5
	36	KAD2	16	KAE1	7	KBF10	2 1/2	JBF4
32	KAD1	14	KAF10	6	KBF7	2 1/4	JBF2	
28	KAE10	13 1/2	KAF9	5 1/2	KBF5	2	JBF1	
	LEAD SCREW – 4TPI							
C								
0.5	KSF1	2	KSD1	4.5	KUD2	9	JUD2	
0.75	KSF7	2.25	KSD2	5	KUD4	10	JUD4	
1	KSE1	2.5	KSD4	5.5	KUD5	11	JUD5	
1.25	KSE4	3	KSD7	6	KUD7	12	JUD7	
1.5	KSE7	3.5	KSD10	7	KUD10	13	JUD8	
1.75	KSE10	4	KUD1	8	JUD1	14	JUD10	

5. LUBRICATION

5-1 Headstock Lubrication

Headstock lubrication is splash injection type. Oil grooves are equipped around the headstock to provide lubricant flowing from oil grooves to spindle, then finally reach the bottom of the headstock. To add oil, take off the oil plug on the top of the headstock cover, fill to the centerline of oil sight glass. Oil drain hole is located on the right bottom side of the headstock.

Before operating the lathe, be sure the headstock is filled with oil. If not, add Shell Tellus #32. Exchange oil after one month use for the first time. Thereafter every two months.

5-2 Gear Box & Apron Lubrication

1. Gear box is reservoir oil bath type. To ensure the long service life of gear box and bedways, exchange the oil of gear box every six months.
2. Apron is also reservoir oil bath type. Add the oil as soon as the oil is lower than the center line of the oil sight glass.

5-3 Lubrication Charts

No.	Location	Methods	Lubricant No.	Quantity	Oil time	Exchange time
1	Headstock	Loosen the oil input hole screw on the left top side of the headstock cover	#32	L	Once per month	One month at the beginning, thereafter once two months
2	Gear Box	Open the top cover and loosen the oil input hole screw.	#50	L	Once per month	Every six months
3	Apron	Loosen the oil input hole screw	#68	L	Once per day	
4	Compound rest	Add oil with oil can	#68	As required	Once per day	
5	Auto Feeding rod	Add oil with oil can	#68	As required	Once per day	
6	Tailstock	Add oil with oil can	#68	As required	Once per day	
7	Leadscrew	Add oil with oil can	#68	As required	Once per day	
8	Bedway	Press the manual oil pump	#68	As required	Once per day	

5-4 Lubrication Location

A: Oil input hole
B: Oil drain hole

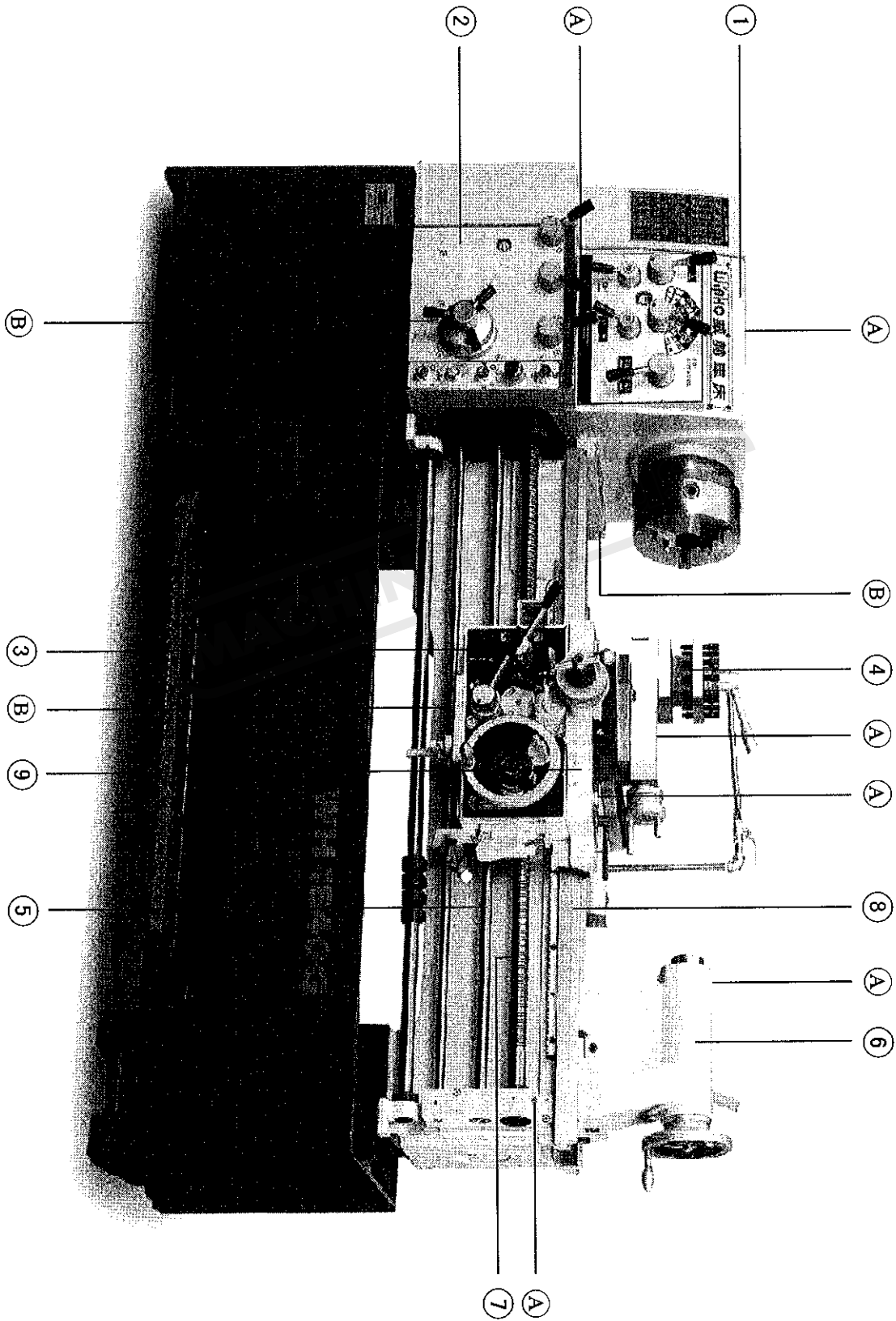

6. MAINTENANCE & ADJUSTMENT

Please refer to following items for machine problem solution and maintenance for obtaining the best function and the long service life of the lathe.

6-1 Headstock

1. To avoid the headstock cover oil leaking: Once the headstock cover is opened, use cloth to clean the connecting surface and apply some grease, then can close the cover and tighten the set screw.
2. To avoid the returning oil route being blocked: There are two reasons which cause the oil leaking from headstock front cover; one is over oiled; the other is that the returning oil route is blocked. It should take off the headstock cover. Then blow air to the small hole, which is on the top of the front bearing, by air gun several times. And rotate the spindle at the same time to clean up the blocked returning oil route.
3. Spindle bearing adjustment: The front and middle bearings of the spindle is precision taper roller type. It requires to adjust the bearings to have suitable preload for maintaining the high accuracy and the best rotating functions. After long use the locking nut G may be loose a little bit and result in uneven cutting surface. For adjustment, loosen the setscrew by hexagon wrench. Then tighten the locking nut G to obtain the suitable preload. Do not over-tighten as over-preload will make the bearings hot, damage the rotating surface of the bearings and lower down the bearing motion functions. After adjustment, be sure to tighten the locking screw completely.

Ⓒ

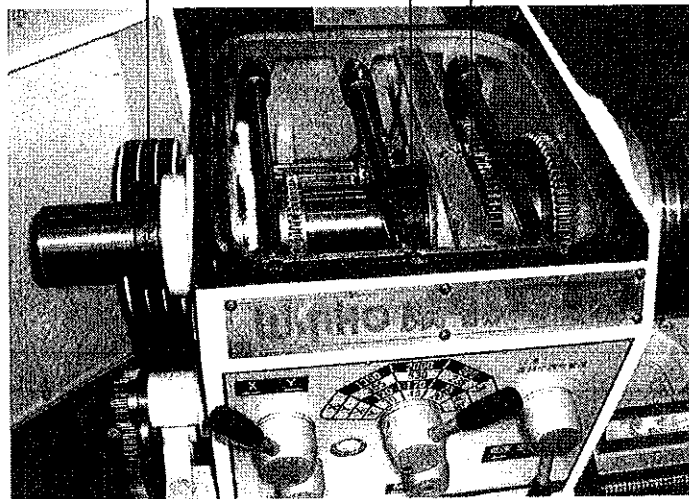

6-2 Apron & Saddle

1. Apron lubrication location: on the right top side of the saddle base, the oil inlet plug marked "OIL" is the oil inlet hole.
2. Apron drain hole located on the bottom cover of the apron as shown on the right side figure, the drain plug marked (A) (also see the chart on the front bottom side of the apron).
3. Oil brand and oil exchange time: Use Shell Tellus No. 220 and exchange the oil half a year.
4. To adjust the half nut engaged lever: After long use, the lever may be loosened and needed to be adjusted. First, take off the thread dial indicator and find the 4 gib strip adjusting screws. Second, while pressing the lever, also adjust the 4 gib strip adjusting screws until they are properly tightened. Afterwards, replace the thread dial indicator.
5. To clear up and repair the manual pump being blocked or small oil flow: If no oil oozes out after pushing the manual pump several times, the pump is blocked. Take off the 4 setscrews of the pump body and loosen the plug lever to dismantle the set nut. Use air gun to clean up the inside of the blocked pump. If the oil flow is too small, it must be the O-ring worn out, replace another new O-ring and assemble back the dismantled parts accordingly.
6. Adjustment for the longitudinal & cross auto feeding overload: The cone clutch on the center of the apron is an overload device. The safety overload weight limitation is 12 Kg. Overload weight can be adjusted by means of the Hexagon screw on the center of the apron; tighten clockwise, the overload will increase; tighten anticlockwise, the overload will then decrease. When auto-feeding, press the handwheel by hand, it should automatically slip out if the overload is over 12Kg. If not, adjust again.

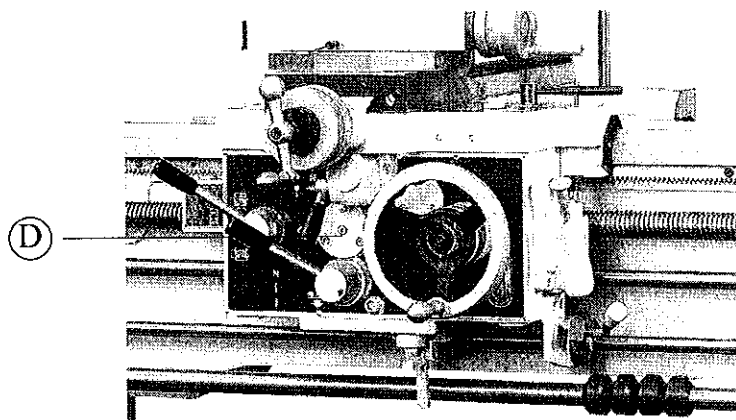
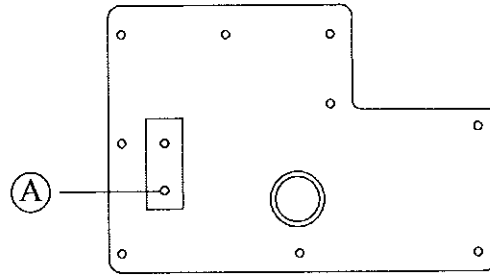

6-3 Gear Box

1. Lubrication location: Below the top cover of the apron, take off the top cover to find the oil plug marked "OIL", the oil inlet hole.
2. Drain hole: On the left bottom side of the 10-step feed selection dial. The screw with hexagon nut is the oil drain hole as arrow ② shown on figure 6-3.
3. Oil brand and oil exchange time: Use Shell Tellus No. 220 and exchange the oil half a year.

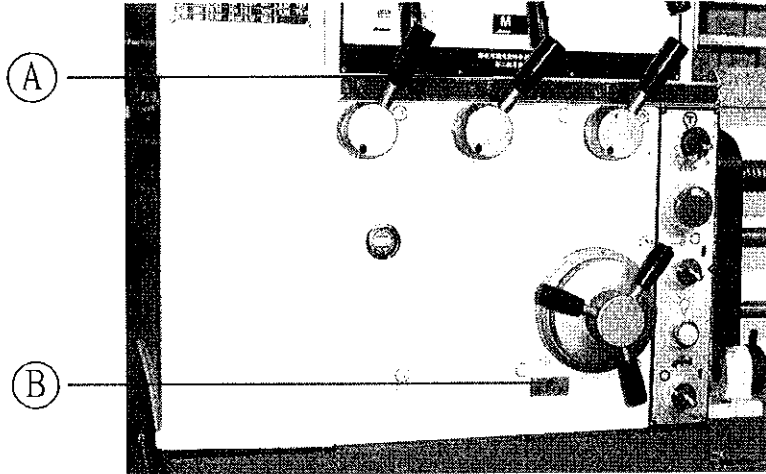

Fig. 6-3

6-4 Tailstock Center Line Adjustment

First, unclamp the tailstock body clamping lever, and then loosen the 2 hexagon head screw on both right and left sides which lock the tailstock body and base together. Determine the direction and amount of the misalignment for adjustment by positioning a test bar between two dead centers. Slacken the rear 'location screw' (say one half turn). Then alternatively slacken one set-over screw and tighten the other until the required setting is achieved, (correct alignment). Carefully retighten the rear 'location screw' and the set over screw which was slackened before and recheck alignment. Retighten the two hexagon head screw carefully and re-clamp the tailstock (Fig. 6-4)

If still can not operate the handwheel easily after the tailstock quill is fixed, it is caused by the reason that the clamping block can not be loosened. To solve it, just push the tailstock body clamping lever forward one time for recovering.

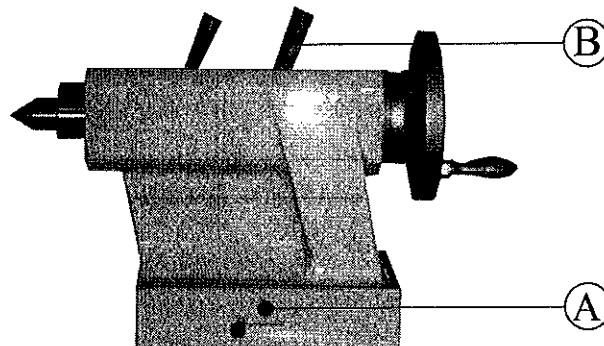

Fig. 6-4

6-5 Belt Tension Adjustment

After long use, the belt will stretch and require periodic tension adjustment.

1. Take off the cover on the left back side of the lathe.
2. Loosen adjusting nut **(A)** and lower down the suitable height until the desired belt tension is achieved.
3. After adjustment, be sure to tighten the adjusting nut securely.

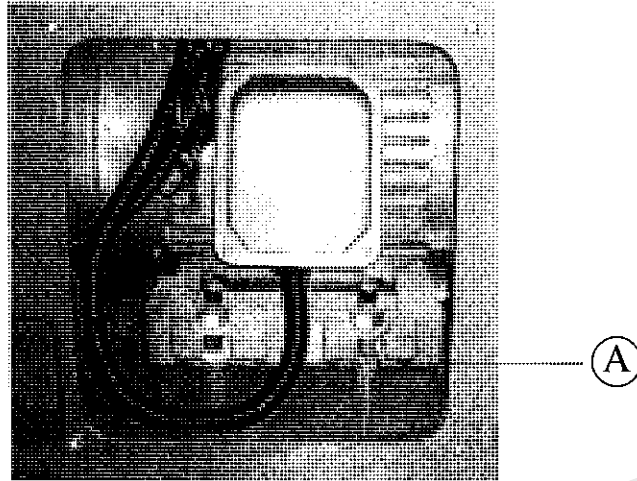

Fig 6-5

6-6 Brake Belt Adjustment

If the brake belt is worn out and cause the brake band tool loosen, it is time to adjust the nut **(H)** of the brake band. Remove the side rear cover, loosen the nuts on the top firstly and tighten the nuts on the bottom to the appropriate height. Then tighten the nuts on the top to complete the adjustment. After adjustment, replace the side rear cover.

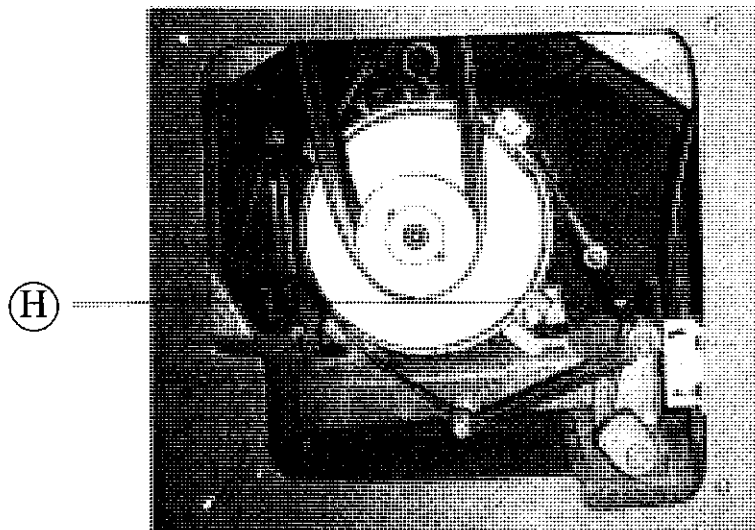

Fig 6-6

6-7 Brake & Micro Switch Adjustment

The foot brake is connected with the micro switch. It should have 0-1mm end play between the brake arm and the touching, head of the micro switch. The correct brake action should cut off the electricity first, then brake to avoid the brake belt being worn out. After stepping the foot brake, needs to re-operate the spindle operation control lever to make the spindle revolute again.

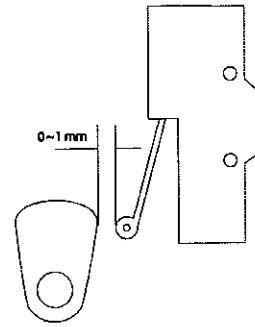
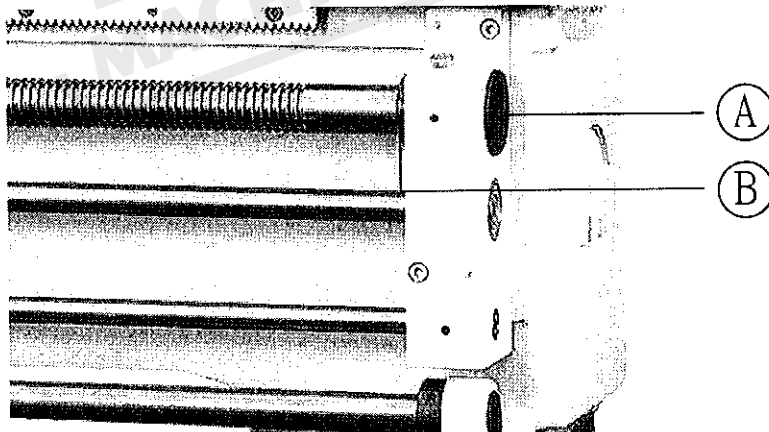

Fig. 6-7

6-8 Leadscrew Backlash Adjustment

If multiple cutting is happened while threading, it is caused by the leadscrew backlash. To adjust the leadscrew half nut properly, open the plastic cover of the leadscrew bracket and loosen nut (A). Then tighten the left side nut (B) until there is no backlash. (For testing, press down the half nut by hand, turn the apron handwheel forward and reverse and grasp the connecting section of the gear box and leadscrew till no backlash happened.) Afterwards, replace the nut (A) to the leadscrew bracket.



6-9 Cutting Coolant Repair

If there is no coolant coming out after the pump switch is turned on, check the pump motor is working or not. If yes, check and see if the coolant in the tank is over the pump or not, If not, add the coolant, then turn on the switch, If there is still no coolant, the pump must be blocked. Take off the pump to clean up or repair.

PART LIST

1. HEADSTOCK
2. GEAR BOX
3. APRON
4. BED AND BASE
5. BRAKE SYSTEM
6. CARRIAGE AND CROSSFEED
- 6A. CARRIAGE AND CROSSFEED
7. TAILSTOCK
8. STEADY REST ASSEMBLY
9. FOLLOW REST ASSEMBLY
10. COOLANT SYSTEM ASSEMBLY

- 1 HEADSTOCK
- 2 GEAR BOX
- 3 APRON
- 4 BED AND BASE
- 5 BRAKE SYSTEM
- 6 CARRIAGE AND CROSSFEED
- 6A CARRIAGE AND CROSSFEED
- 7 TAILSTOCK

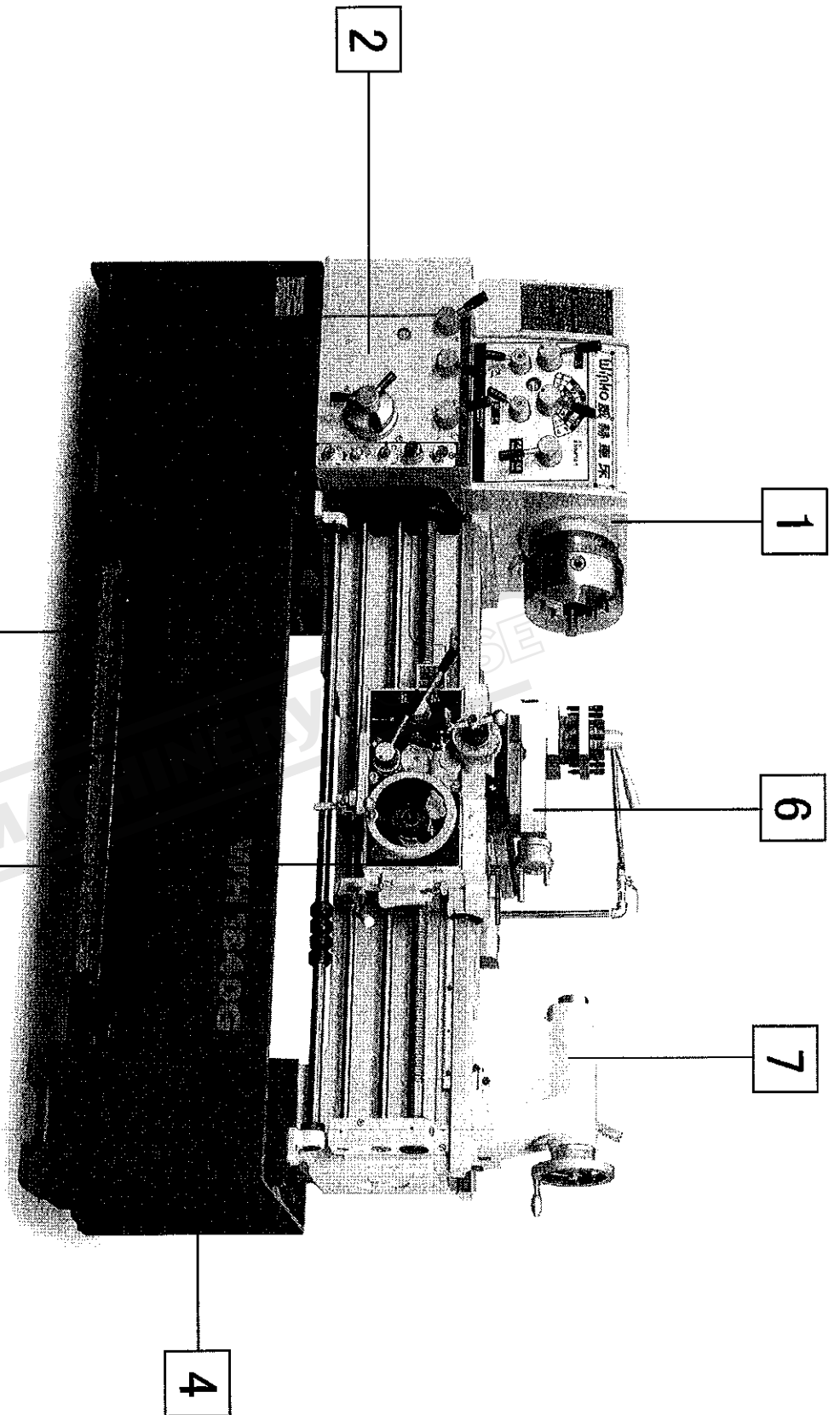

SYSTEM IN EACH UNIT

9-1 HEADSTOCK

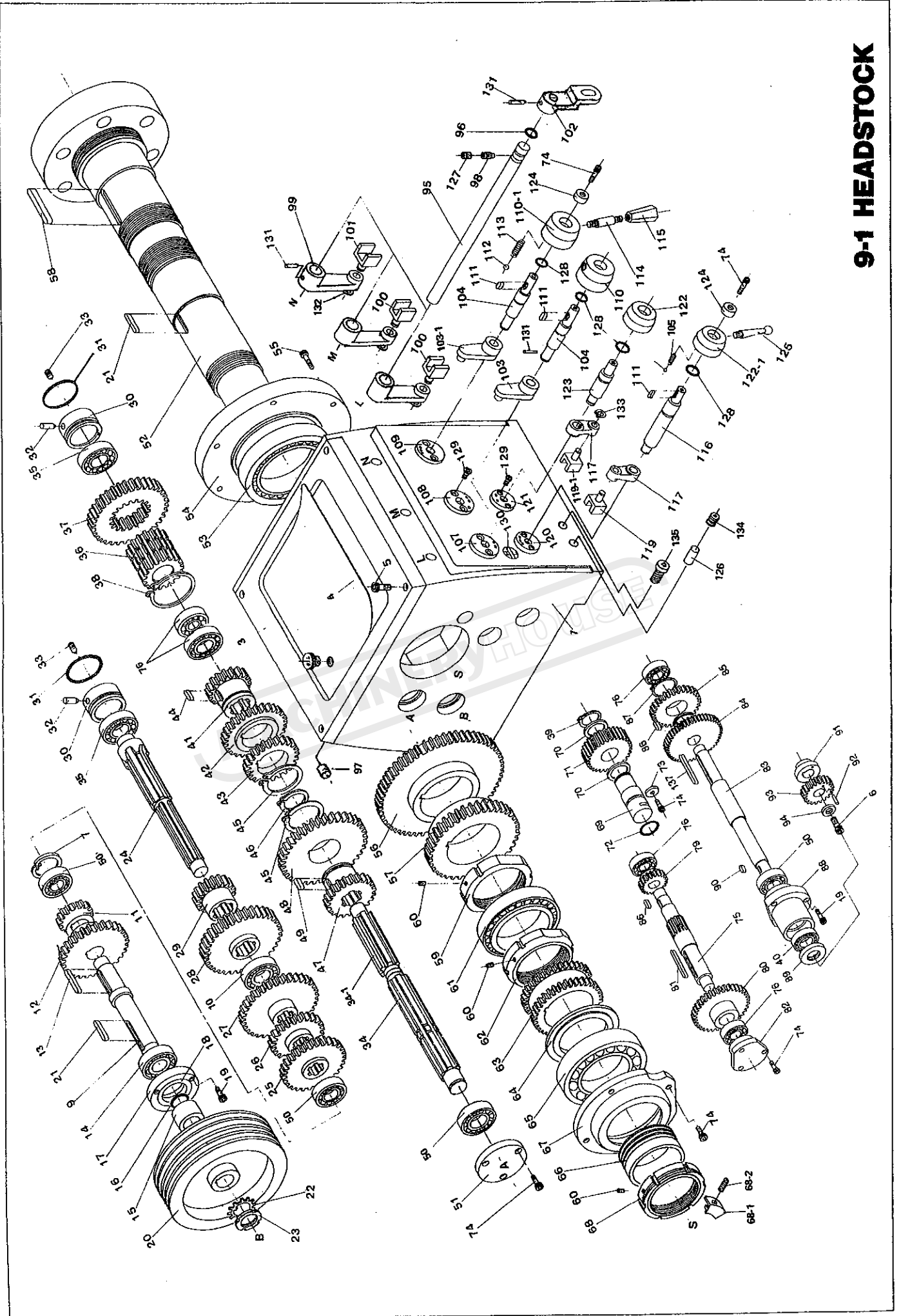

HEADSTOCK ASSEMBLY

Item No.	Part Name	Amt. Used	Type : 16 Part No.	Type : 18 Part No.	Type : 20 Part No.	名稱
1	Head stock	1	1220200609	1220200207	1320200101	主軸箱本體
2	Oil plug	1	1122103405	1122103405	1122103405	油塞
3	Head stock cover	1	1120200509	1120200509	1120200509	主軸箱蓋
4	Blanket	1	1003501701	1003501701	1003501701	主軸箱蓋鐵皮
5	Hexagon socket screw , M8xP1.25x35L	4	91110835	91110835	91110835	六角承窩螺絲
6	Hexagon socket screw , M8xP1.25x25L	1	91110825	91110825	91110825	六角承窩螺絲
7	Snap ring , R48	1				扣環
9	Input-shaft	1	1120200607	1120200607	1120200607	輸入軸
10	Ball bearing , 6206	1	91301021	91301021	91301021	滾珠軸承
11	Gear-i	1	1120200705	1120200705	1120200705	齒輪
12	Gear-g	1	1120200803	1120200803	1120200803	齒輪
13	Square key , 8x7x55L	1	91620804	91620804	91620804	雙圓平行鍵
14	Ball bearing , 6206	2	91301021	91301021	91301021	滾珠軸承
15	Collar	1	1120206501	1120206501	1120206501	間隔圈
17	Housing	1	1120206903	1120206903	1120206903	軸承蓋
18	Oil-seal , TC30x50x8	1	91523001	91523001	91523001	油封
19	Hexagon socket screw , M6xP1.0x25L	6				六角承窩螺絲
20	Pulley	1	1120206305	1220200305	1220200305	從動皮帶輪
21	Square key , 8x7x45L	3	9140360000002	9140360000002	9140360000002	雙圓平行鍵
22	Hexagon socket screw , M12xP1.75x30L	1	91111230	91111230	91111230	六角承窩螺絲
23	Spring washer , 12	1				彈簧華司
24	Shaft-B	1	1120202503	1120202503	1120202503	B軸
25	Gear-d	1	1120200901	1120200901	1120200901	齒輪
26	Gear-b	1	1120201006	1120201006		齒輪
27	Gear-f	1	1120201104	1120201104	1120201104	齒輪
28	Gear-k	1	1120201202	1120201202	1120201202	齒輪
29	Gear-o	1	1120201300	1120201300	1120201300	齒輪
30	Plug-cover	2	1120202905	1120202905	1120202905	護蓋
31	O-ring , P55x3.5	2	9151P055	9151P055	9151P055	O型環
32	Fixed pin	2	1120206707	1120206707	1120206707	護蓋固定銷
33	Set screw	2	1120206805	1120206805	1120206805	固定螺絲
34	Shaft-A	1	1120202601	1120202601	1120202601	A軸
34-1	Shaft-L	1	1120208505	1120208505	1120208505	L軸
35	Ball-bearing , 6305	2	91301029	91301029	91301029	滾珠軸承
36	Gear-l	1	1120201408	1120201408	1120201408	齒輪
37	Gear-m	1	1320200209	1320200209	1320200209	齒輪
38	Snap ring , S65	2				扣環
39	Snap ring , S30	1	9171S030	9171S030	9171S030	扣環
40	Ball bearing , 6005	3	91301010	91301010	91301010	滾珠軸承
41	Gear-e	1	1120201506	1120201506	1120201506	齒輪
42	Gear-a	1	1320200307	1320200307	1320200307	齒輪
43	Gear-c	1	1320200405	1320200405	1320200405	齒輪
44	Square key , 8x7x35L	1	91620802	91620802	91620802	雙圓平行鍵
45	Snap ring , S48	2				扣環

HEADSTOCK ASSEMBLY

Item No.	Part Name	Amt. Used	Type : 16 Part No.	Type : 18 Part No.	Type : 20 Part No.	名稱
46	Snap ring , S34	1	9171S034	9171S034	9171S034	扣環
47	Gear-h	1	1120201604	1120201604	1120201604	齒輪
48	Gear-j	1	1320200503	1320200503	1320200503	齒輪
49	Square key , 8x7x25L	1	91620801	91620801	91620801	雙圓平行鍵
50	Ball bearing , 6205	2	91301020	91301020	91301020	滾珠軸承
51	Cover	1	1120203108	1120203108	1120203108	護蓋
52	Spindle (A1-6)	1	1120200401	1120200401	1120200401	主軸
	(D1-6)	1	1120200303	1120200303	1120200303	
53	Taper roller bearing , 32018	1	91302014	91302014	91302014	滾錐軸承
54	Cover (A1-6)	1	1120200107	1120200107	1120200107	主軸前護蓋
	(D1-6)	1	1120200205	1120200205	1120200205	
55	Hexagon socket screw , M6xP1.0x35L	6	91110635	91110635	91110635	六角承窩螺絲
56	Gear-p	1	1120201702	1120201702	1120201702	齒輪
57	Gear-n	1	1120201800	1120201800	1120201800	變速齒輪
58	Square key , 8x7x85L	1	91620806	91620806	91620806	雙圓平行鍵
59	Lock-nut	1	1120203206	1120203206	1120203206	逼緊螺帽
60	Set screw , M8xP1.25x8L	5	91120808	91120808	91120808	固定螺絲
61	Taper roller bearing , 32017	1	91302013	91302013	91302013	滾錐軸承
62	Lock-nut	1	1120203304	1120203304	1120203304	逼緊螺帽
63	Gear	1	1120201908	1120201908	1120201908	齒輪
64	Collar	1	1120203402	1120203402	1120203402	軸環
65	Ball bearing , 6215	1	91301024	91301024	91301024	滾珠軸承
66	Oil return collar	1	1120203500	1120203500	1120203500	回油軸環
67	Cover	1	1120203608	1120203608	1120203608	主軸後護蓋
68	Lock nut	1	1120203706	1120203706	1120203706	逼緊螺帽
68-1	Balance piece	2	1120203804	1120203804	1120203804	平衡片
68-2	Set screw	4	1120207008	1120207008	1120207008	定位螺絲
69	Idle gear shaft	1	1120207508	1120207508	1120207508	惰輪軸
70	Spacer	2	1120206609	1120206609	1120206609	間隔圈
71	Idle gear	1	1120202003	1120202003	1120202003	惰輪
72	O-ring , P29	1	9151P029	9151P029	9151P029	O型環
73	Washer	1	1120207606	1120207606	1120207606	墊圈
74	Hexagon socket screw , M6xP1.0x16L	16	91110616	91110616	91110616	六角承窩螺絲
75	Gear shaft-C	1	1120202101	1120202101	1120202101	齒輪軸
76	Ball bearing , 6204	5	91301018	91301018	91301018	滾珠軸承
79	Gear	1	1120202209	1120202209	1120202209	齒輪
80	Gear	1	1120202307	1120202307	1120202307	齒輪
81	Square key , 6x6x65L	1				雙圓平行鍵
82	Cover	1	1120203902	1120203902	1120203902	護蓋
83	Shaft-D	1	1120202807	1120202807	1120202807	D軸
84	Gear	1	1120202405	1120202405	1120202405	齒輪
85	Gear	1	1320200601	1320200601	1320200601	齒輪
86	Square key , 6x6x18L	2	91610604	91610604	91610604	雙圓平行鍵
87	Snap ring , S40	1	9171S040	9171S040	9171S040	扣環
88	Housing	1	1120204007	1120204007	1120204007	後列齒輪軸護蓋
89	Oil-seal , TC25x47x8L	1	91522501	91522501	91522501	油封

HEADSTOCK ASSEMBLY

Item No.	Part Name	Amt. Used	Type : 16 Part No.	Type : 18 Part No.	Type : 20 Part No.	名稱
90	Square key , 6x6x12L	1	91610601	91610601	91610601	雙圓平行鍵
91	Collar	1	1121602203	1121602203	1121602203	軸環
92	Taper pin , 0#x25L	1	82010025	82010025	82010025	推拔銷
93	Gear (24T in)	1	1121600405	1121600405	1121600405	輸出齒輪
	Gear (41T mm)	1	1121600307	1121600307	1121600307	
94	Washer	1				特殊墊塊
95	Shifting shaft	3	1120204105	1120204105	1120204105	撥桿軸
96	O-ring , P16	6	9151P016	9151P016	9151P016	O型環
97	Plug	3	1120207704	1120207704	1120207704	塞子
98	Set screw	3	1120204203	1120204203	1120204203	定位螺絲
99	Shifting lever	3	1120204301	1120204301	1120204301	搖臂
100	Shifting fork	2	1120207802	1120207802	1120207802	撥塊
101	Shifting fork	1	1120204409	1120204409	1120204409	撥塊
102	Shifting lever	3	1120204507	1120204507	1120204507	撥叉
103	Shifting lever	2	1120204605	1120204605	1120204605	搖臂
103-1	Shifting lever	1	1120204703	1120204703	1120204703	搖臂
104	Shaft	3	1120204801	1120204801	1120204801	撥桿軸
105	Spring , D6xd0.8x25L	2	91901060102902	91901060102902	91901060102902	彈簧
106	Ball steel , ϕ 1/4"	2				鋼珠
107	Detent plate	1	1120204909	1120204909	1120204909	定位片
108	Detent plate	1	1120205004	1120205004	1120205004	定位片
109	Detent plate	1	1120205102	1120205102	1120205102	定位片
110	Hub	2	1120205200	1120205200	1120205200	變速把手
110-1	Hub	1	1120205308	1120205308	1120205308	變速把手
111	Square key , 5x5x15L	2	91610501	91610501	91610501	雙圓平行鍵
112	Ball steel , ϕ 5/16"	3				鋼珠
113	Spring , D8xd0.8x25L	3				彈簧
114	Lever	3	1120207302	1120207302	1120207302	撥桿軸套
115	Knob	3	1120207400	1120207400	1120207400	電木把手
116	Shaft	1	1120208309	1120208309	1120208309	撥桿軸
117	Shifting lever	2	1120205504	1120205504	1120205504	搖臂
118	Shifting fork	1	1120208005	1120208005	1120208005	撥塊
119	Shifting fork	1	1120205602	1120205602	1120205602	撥塊
119-1	Shifting fork	1	1120205602	1120205602	1120205602	撥塊
120	Detent plate	1	1120205700	1120205700	1120205700	定位片
121	Detent plate	1	1120205808	1120205808	1120205808	定位片
122	Knob	1	1120205906	1120205906	1120205906	變速把手
122-1	Knob	1	1120206001	1120206001	1120206001	變速把手
123	Shaft	1	1220200403	1220200403	1220200403	撥桿軸
124	Washer	5	1120206109	1120206109	1120206109	墊圈
125	Lever	2	1120207204	1120207204	1120207204	電木把手
126	Pin	2	1121600709	1121600709	1121600709	調整銷
127	Set screw , M8xP1.25x10L	3	91120810	91120810	91120810	固定螺絲
128	O-ring , P18xP1.0x14L	5				O型環
129	Screw , M6xP1.0x14L	10	91160614	91160614	91160614	六角孔埋頭螺絲
130	Lenz-oil , ϕ 28	1	93902003000004	93902003000004	93902003000004	油鏡
131	Spring pin , ϕ 5x32L	9				彈簧銷

HEADSTOCK ASSEMBLY

Item No.	Part Name	Amt. Used	Type : 16 Part No.	Type : 18 Part No.	Type : 20 Part No.	名稱
	Spring pin , ϕ 5x26L	2	92030526	92030526	92030526	
132	Snap ring , S12	3	9171S012	9171S012	9171S012	扣環
133	Snap ring , S10	2				扣環
134	Set screw , M10xP1.5x20L	2	91121020	91121020	91121020	固定螺絲
135	Hexagon socket screw , M10xP1.5x95L	2	91111095	91111095	91111095	六角承窩螺絲
136	Hexagon socket screw , M6xP1.0x40L	4	91110640	91110640	91110640	六角承窩螺絲
137	Square key , 6x6x70L	1	91610608	91610608	91610608	雙圓平行鍵

MACHINERYHOUSE

9-2 GEAR BOX

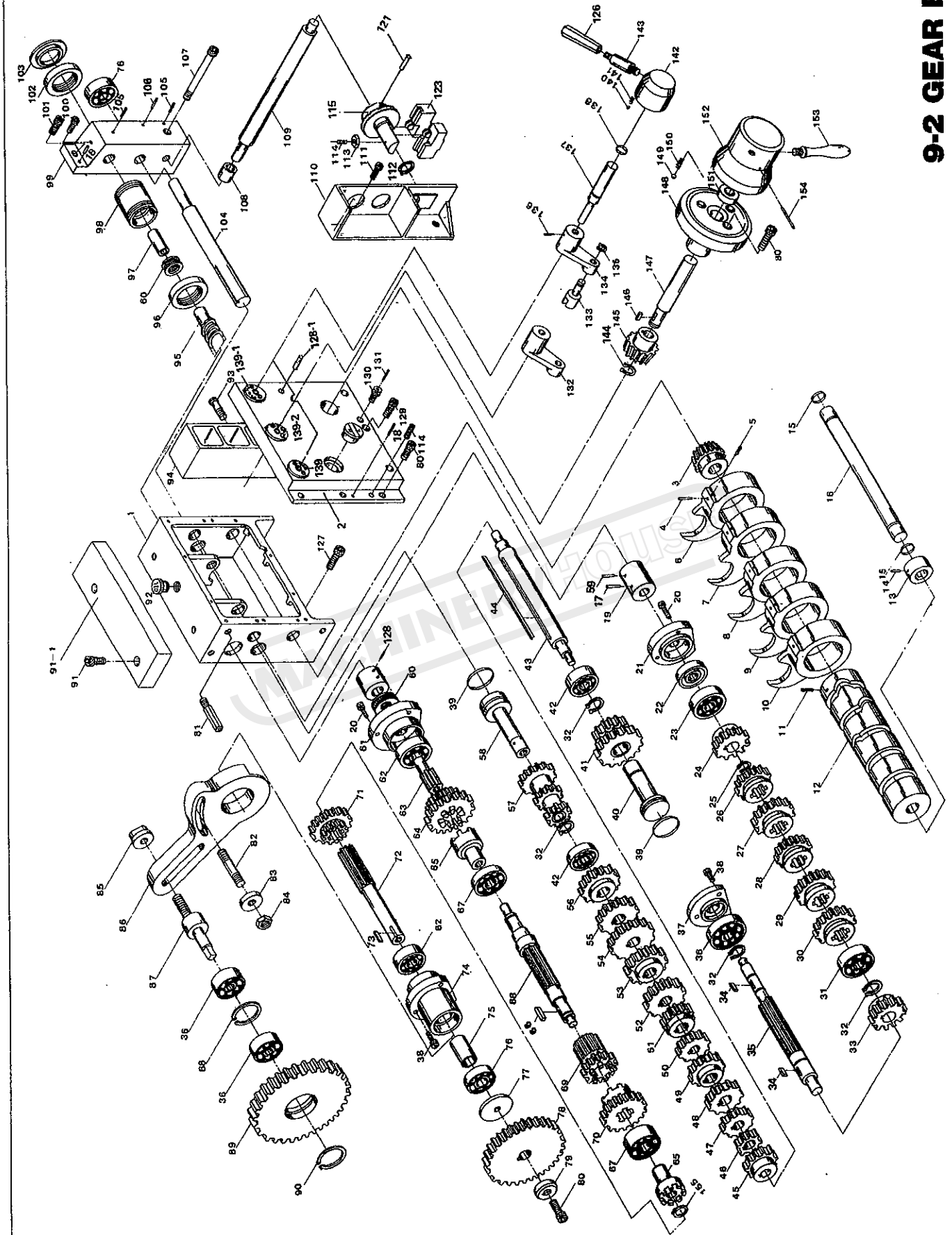

GEAR BOX ASSEMBLY

Item No.	Part Name	Amt. Used	Type : 16 Part No.	Type : 18 Part No.	Type : 20 Part No.	名稱
1	Gear box	1	1210300307	1210300307	1210300307	齒輪箱本體
2	Cover-gear box	1	1210300101	1210300101	1210300101	齒輪箱蓋
3	Gear-driven bevel	1	1210300405	1210300405	1210300405	從動傘齒輪
4	Pin-fixed	5	1210300503	1210300503	1210300503	固定銷
5	Pin-split	5	92004000000014	92004000000014	92004000000014	開口銷
6	Claw-shifter	1	1210300601	1210300601	1210300601	撥爪
7	Claw-shifter	1	1210300709	1210300709	1210300709	撥爪
8	Claw-shifter	1	1210300807	1210300807	1210300807	撥爪
9	Claw-shifter	1	1210300905	1210300905	1210300905	撥爪
10	Claw-shifter	1	1210301000	1210301000	1210301000	撥爪
11	Screw-hexa. socket headless set, M8xP1.25x8L	1	1210301108	1210301108	1210301108	固定螺絲
12	Cam-shifter	1	1210301206	1210301206	1210301206	變速凸輪
13	Collar	1	1210301304	1210301304	1210301304	H軸固定環
14	Set screw, M8x12	2	9111008012	9111008012	9111008012	車削止付
15	Ring-"O", P18	2	9151P018	9151P018	9151P018	O型環
16	Shaft-"A"	1	1210301402	1210301402	1210301402	H軸
17	Pin-taper, 4x38	3	92010438	92010438	92010438	推拔銷
18	Pin-taper, 6x38	2	1210702301	1210702301	1210702301	推拔銷
19	Collar-linkage	1	1210301500	1210301500	1210301500	螺桿連接軸
20	Screw-hexa. socket head cap, M6xP1.0x16L	6	91110616	91110616	91110616	六角承窩螺絲
21	Cap-right	1	1210301608	1210301608	1210301608	右下護蓋
22	Seal-oil, 20x40x10L	1	91522001	91522001	91522001	油封
23	Bearing-ball, 6204	1	91301018	91301018	91301018	滾珠軸承
24	Gear-"B" shaft	1	1210301706	1210301706	1210301706	G軸固定齒輪
25	Snap ring, S25	2	9171S025	9171S025	9171S025	扣環
26	Gear-"B" shaft	1	1210301804	1210301804	1210301804	G軸變速齒輪
27	Gear-"B" shaft	1	1210301902	1210301902	1210301902	G軸變速齒輪
28	Gear-"B" shaft	1	1210302007	1210302007	1210302007	G軸變速齒輪
29	Gear-"B" shaft	1	1210302105	1210302105	1210302105	G軸變速齒輪
30	Gear-"B" shaft	1	1210302203	1210302203	1210302203	G軸變速齒輪
31	Bearing-ball, 6004	1	91301006	91301006	91301006	滾珠軸承
32	Snap ring, S20	2	9171S020	9171S020	9171S020	扣環
33	Gear-"B" shaft	1	1210302301	1210302301	1210302301	G軸固定齒輪
34	Key-square, 6x6x20L	2	91610605	91610605	91610605	雙圓平行鍵
35	Shaft-"B"	1	1210302409	1210302409	1210302409	G軸
36	Bearing-ball, 6003	3	91301005	91301005	91301005	滾珠軸承
37	Cap-left	1	1210302507	1210302507	1210302507	左下護蓋
38	Screw-hexa. socket head cap, M6xP1.0x12L	6	91110612	91110612	91110612	六角承窩螺絲
39	Ring-"O", P36	2	9151P036	9151P036	9151P036	O型環
40	Shaft-"C"	1	1210302605	1210302605	1210302605	E軸
41	Gear-"C" shaft	1	1210302703	1210302703	1210302703	E軸齒輪
42	Bearing, 6203	2	91301016	91301016	91301016	滾珠軸承
43	Shaft-"D"	1	1210302801	1210302801	1210302801	D軸
44	Key-square, 6x6x146L	1				雙圓平行鍵
45	Gear-"D" shaft	1	1210302909	1210302909	1210302909	D軸齒輪

GEAR BOX ASSEMBLY

Item No.	Part Name	Amt. Used	Type : 16 Part No.	Type : 18 Part No.	Type : 20 Part No.	名稱
46	Gear-"D" shaft	1	1210303004	1210303004	1210303004	D軸齒輪
47	Gear-"D" shaft	1	1210303102	1210303102	1210303102	D軸齒輪
48	Gear-"D" shaft	1	1210303200	1210303200	1210303200	D軸齒輪
49	Gear-"D" shaft	1	1210303308	1210303308	1210303308	D軸齒輪
50	Gear-"D" shaft	1	1210303406	1210303406	1210303406	D軸齒輪
51	Gear-"D" shaft	1	1210303504	1210303504	1210303504	D軸齒輪
52	Gear-"D" shaft	1	1210303602	1210303602	1210303602	D軸齒輪
53	Gear-"D" shaft	1	1210303700	1210303700	1210303700	D軸齒輪
54	Gear-"D" shaft	1	1210303808	1210303808	1210303808	D軸齒輪
55	Gear-"D" shaft	1	1210303906	1210303906	1210303906	D軸齒輪
56	Gear-"D" shaft	1	1210304001	1210304001	1210304001	D軸齒輪
57	Gear-"E" shaft	1	1210304109	1210304109	1210304109	E軸齒輪
58	Shaft-"E"	1	1210304207	1210304207	1210304207	E軸
59	Pin-taper , 3x38	1	1003502904	1003502904	1003502904	鋁斜銷
60	Bearing-thrust , 51104	2	91303003	91303003	91303003	止推軸承
61	Cap	1	1210304305	1210304305	1210304305	右上導套
62	Bearing-ball , 6004V	2	91301008	91301008	91301008	滾珠軸承
63	Shaft-"F"	1	1210304403	1210304403	1210304403	C軸
64	Gear-"F" shaft	1	1210304501	1210304501	1210304501	C軸齒輪
65	Gear-"F" shaft (left)	1				C軸齒輪
	(right)	1				
66	Square key , 4x4x20L	2	91610401	91610401	91610401	雙圓平行鍵
67	Bearing-ball , 6005	2	91301010	91301010	91301010	滾珠軸承
68	Shaft-"G"	1	1210304805	1210304805	1210304805	A軸
69	Gear-"G" shaft	1	1210304903	1210304903	1210304903	A軸變速齒輪
70	Gear-"G" shaft	1	1210305008	1210305008	1210305008	A軸變速齒輪
71	Gear-"H" shaft	1	1210305106	1210305106	1210305106	B軸離合齒輪
72	Shaft-"H"	1	1210300209	1210300209	1210300209	B軸
73	Key-square , 6x6x13L	1	91610602	91610602	91610602	單圓平行鍵
74	Cap-bearing	1	1210305204	1210305204	1210305204	軸承套
75	Bushing-"H" shaft	1	1210305302	1210305302	1210305302	間隔圈
76	Bearing-ball , 6004Z	1	91301007	91301007	91301007	滾珠軸承
77	Spacer	1	1121600905	1121600905	1121600905	B軸擋塊
78	Gear-drive shaft (57T in)	1	1121600601	1121600601	1121600601	傳動齒輪
	(92T mm)	1	1121600503	1121600503	1121600503	
79	Washer	1	1121602105	1121602105	1121602105	特殊墊塊
80	Screw-hexa. socket head cap, M8xP1.25x16L	1	91110816	91110816	91110816	六角承窩螺絲
81	Bolt-lock end cover	1	1122100208	1122100208	1122100208	側蓋鎖緊螺栓
82	Stud	1	1121601108	1121601108	1121601108	螺栓
83	Washer , 1/2	1	1121602301	1121602301	1121602301	墊塊
84	Nut , W1/2	1	91210016	91210016	91210016	螺帽
85	Nut-lock stud	1	1121601706	1121601706	1121601706	齒輪軸螺帽
86	Quadrat	1	1121601000	1121601000	1121601000	可調支架
87	Stud-gear	1	1121601206	1121601206	1121601206	活動齒輪軸
88	Snap ring , R35	1	9171R035	9171R035	9171R035	扣環
89	Gear-quadrat (71T in)	1	1121600209	1121600209	1121600209	惰輪

GEAR BOX ASSEMBLY

Item No.	Part Name	Amt. Used	Type : 16 Part No.	Type : 18 Part No.	Type : 20 Part No.	名稱
	(84T mm)	1	1121600101	1121600101	1121600101	
90	Snap ring , S16	1				扣環
91	Screw-hexa. socket head cap, M6xP1.0x25L	2	91110625	91110625	91110625	六角承窩螺絲
91-1	Cover	1	1222100200	1222100200	1222100200	齒輪箱上蓋
92	Plug-oil inlet	1	1122101401	1122101401	1122101401	油塞
93	Screw-hexa. socket head cap, M6xP1.0x65L	2				六角承窩螺絲
94	Seat-pilot light		121071206	121071206	121071206	指示燈座
95	Lead-screw (5 feet in)	1	1210700209	1210700209	1210700209	導螺桿
	(5 feet mm)	1	1210700101	1210700101	1210700101	
	(6 feet in)	1	1220700202	1220700202	1220700202	
	(6 feet mm)	1	1220700104	1220700104	1220700104	
	(8 feet in)	1	1230700205	1230700205	1230700205	
	(8 feet mm)	1	1230700107	1230700107	1230700107	
	(10 feet in)	1	1240700208	1240700208	1240700208	
	(10 feet mm)	1	1240700100	1240700100	1240700100	
96	Nut-lock	1	1210700709	1210700709	1210700709	導螺桿調整軸套
97	Bushing-leadscrew	1				
98	Plug-lead screw	1	1210700709	1210700709	1210700709	導螺桿調整軸套
99	rod	1	1210700807	1210700807	1210700807	三桿支架
100	Screw-hexa. socket head cap, M8xP1.25x25L	1	1122101509	1122101509	1122101509	銅油塞
101	Screw-hexa. socket head cap, M8xP1.25x30L	1	91110830	91110830	91110830	六角承窩螺絲
102	Nut-lock	1	1210700709	1210700709	1210700709	導螺桿調整軸套
103	Plug-plastic	1	1122101607	1122101607	1122101607	側封蓋
104	Rod-feed	1	1210700307	1210700307	1210700307	自動進刀輸出軸
105	Screw-hexa. socket headless set, M6xP1.0x20L	2				固定螺絲
106	Pin-taper , 6x100L	1	1210700601	1210700601	1210700601	推拔銷
107	Bolt-hexa. socket head cap, M8xP1.25x80L	1				六角承窩螺絲
108	Bushing-spindle starting rod	1	1210700905	1210700905	1210700905	起動桿軸襯
109	feet)	1	1210700405	1210700405	1210700405	啓動桿
	(6 feet)	1	1220700408	1220700408	1220700408	
	(8 feet)	1	1230700401	1230700401	1230700401	
	(10 feet)	1	1240700404	1240700404	1240700404	
110	Seat-switch	1	1210701304	1210701304	1210701304	開關護板
111	Screw-hexa. socket head cap, M8xP1.25x25L	2	91110825	91110825	91110825	六角承窩螺絲
112	Snap ring , S30	1	9171S030	9171S030	9171S030	扣環
113	Nut , M6xP1.0	1	91210006	91210006	91210006	螺帽
114	Screw-hexa. socket headless set, M6xP1.0x20L	1	1210305400	1210305400	1210305400	固定螺絲
115	Bracket	1	1210701402	1210701402	1210701402	起動器
121	Pin , 5x30L	1	92030530	92030530	92030530	彈簧銷
122	Screw-hexa. socket headless set, M6xP1.0x8L	1				

GEAR BOX ASSEMBLY

Item No.	Part Name	Amt. Used	Type : 16 Part No.	Type : 18 Part No.	Type : 20 Part No.	名稱
123	Switch	2				
126	Knob	3	1120207400	1120207400	1120207400	電木把手
127	Screw-hexa. socket head cap, M10xP1.5x35L	4	1210701500	1210701500	1210701500	螺栓
128	Pin-taper , 0x38	1	1003502904	1003502904	1003502904	鋁斜銷
128-1	Pin-taper , 6x45	1	2251002303	2251002303	2251002303	推拔銷
129	Screw-hexa. socket head cap, M8xP1.25x40L	7	91110840	91110840	91110840	六角承窩螺絲
130	Screw-taper , oil outlet , PT3/8	1				方頭油塞
131	Screw-set , taper , PT1/8	1				
132	Shifter	2	1210305606	1210305606	1210305606	變速撥塊
133	Shoe-shifter	3	1210305704	1210305704	1210305704	撥塊
134	Shifter	1	1210306005	1210306005	1210306005	變速撥塊
135	Snap ring , S10	3				扣環
136	Pin-spring , 5x26	3	92030526	92030526	92030526	彈簧銷
137	Shaft-shifter	3	1210306103	1210306103	1210306103	變速撥桿軸
138	Ring-"O" , P12	3	9151P012	9151P012	9151P012	O型環
139	Detent plate	1	1210306201	1210306201	1210306201	變速定位片
139-1	Detent plate	1	1210306309	1210306309	1210306309	變速定位片
139-2	Detent plate	1	1210306407	1210306407	1210306407	變速定位片
140	Ball-steel , 1/4	3				鋼珠
141	Spring , 5x26	3				彈簧
142	Hub	3	1210306505	1210306505	1210306505	把手頭
143	Lever	3	1210306701	1210306701	1210306701	撥桿軸套
144	Snap ring , S15	1	9171S015	9171S015	9171S015	扣環
145	Gear-drive bevel	1	1210306809	1210306809	1210306809	主動傘齒輪
146	Key-square , 5x5x15L	1				雙圓平行鍵
147	Shaft-bevel gear	1	1210306907	1210306907	1210306907	十段變速軸
148	Seat-gear shifting	1	1210307002	1210307002	1210307002	十段變速座
149	Ball-steel , 5/16	1				鋼珠
150	Spring , 8x20	1				彈簧
151	Seal-oil , 20x35x10	1				油封
152	Hub	1				十段變速把手頭
153	Handle	1	1120207204	1120207204	1120207204	把手
154	Pin , 5x50	1	92030550	92030550	92030550	彈簧銷
155	Snap ring , S18	2				扣環

9-6A CARRIAGE AND CROSSFEED

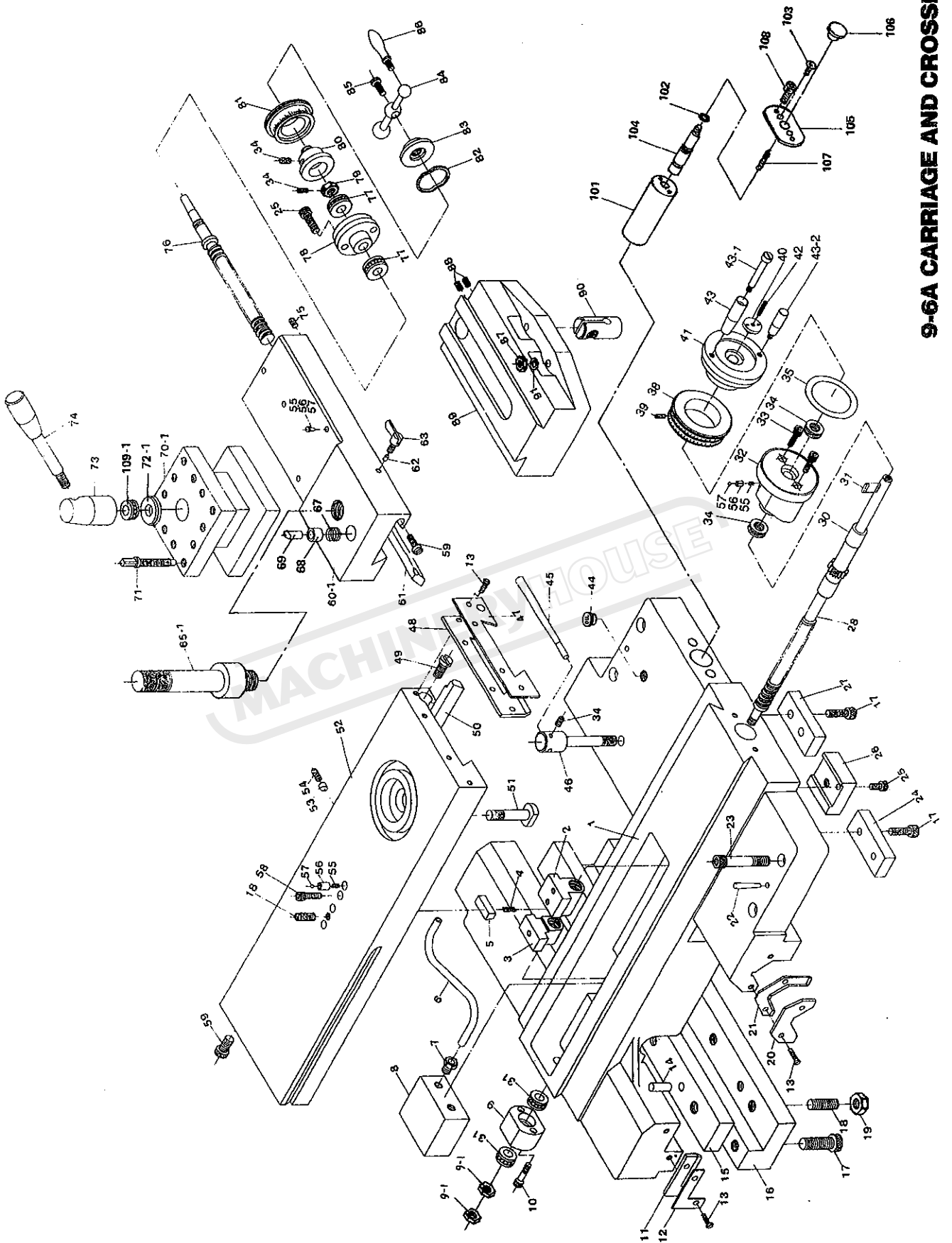

9-3 APRON

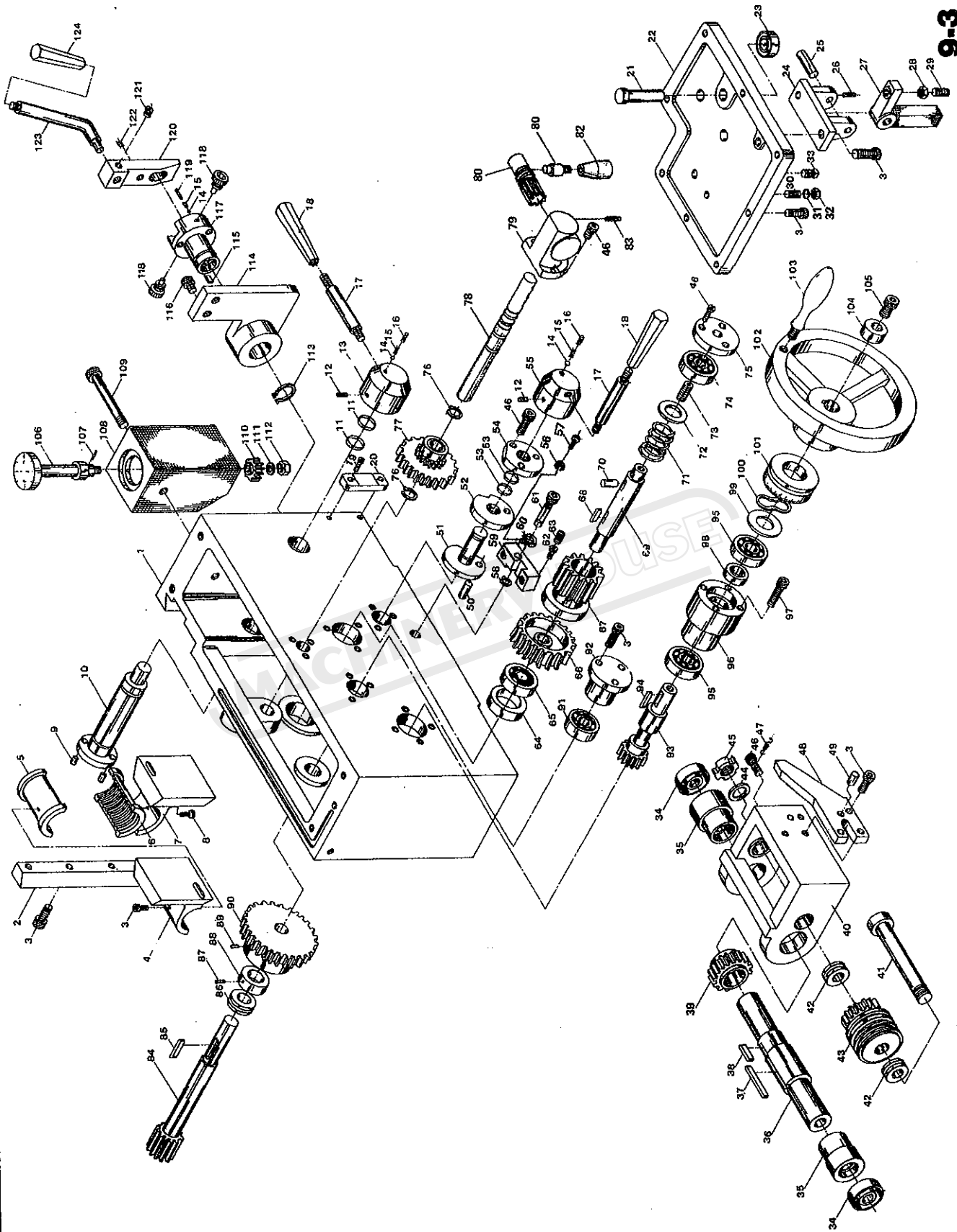

APRON ASSEMBLY

Item No.	Part Name	Amt. Used	Type : 16 Part No.	Type : 18 Part No.	Type : 20 Part No.	名稱
1	Body-Apron (right)	1	1210900209	1210900209	1210900209	護床本體
	(left)	1	1210900101	1210900101	1210900101	
2	Gib	1	1210901706	1210901706	1210901706	炭條
3	Screw-hexa. socket head cap, M6xP1.0x16L	17	91110616	91110616	91110616	六角承窩螺絲
4	Holder-half nut (right)	1	1210900405	1210900405	1210900405	半開螺帽座
	(left)	1	1210900307	1210900307	1210900307	
5	Nut-half (in)	1	121090051	121090051	121090051	半開螺帽
	(mm)	1	121090061	121090061	121090061	
6	Nut-half (in)	1	121090051	121090051	121090051	半開螺帽
	(mm)	1	121090061	121090061	121090061	
7	Holder-half nut	1				
8	Screw-hexa. socket head cap, M6xP1.0x16L	1	91110616	91110616	91110616	六角承窩螺絲
9	Pin-sliding	2	1210902507	1210902507	1210902507	滑塊銷
10	Shaft-half nut (right)	1	1210900807	1210900807	1210900807	半開螺帽心軸
	(left)	1	1210900709	1210900709	1210900709	
11	Ring-O, P26	2	9151P026	9151P026	9151P026	O型環
12	Screw-hexa. socket head cap, M8xP1.25x20L	2	1210902605	1210902605	1210902605	固定螺絲
13	Hub	1				
14	Ball-steel, 1/4"	3				鋼珠
15	Spring, φ 1x6x30L	3	91901060102902	91901060102902	91901060102902	彈簧
16	Screw-hexa. socket headless set, M8xP1.25x10L	2	91120810	91120810	91120810	固定螺絲
17	Lever	2	1210902703	1210902703	1210902703	手柄
18	Knob	2				
19	Screw-hexa. socket head cap, M10xP1.5x25L	2	91111025	91111025	91111025	六角承窩螺絲
20	Lenx-oil	1	1210902801	1210902801	1210902801	油鏡
21	Shaft-auto stop	1	1210902909	1210902909	1210902909	挺桿
22	Cover-bottom apron	1	1210903004	1210903004	1210903004	護床底蓋
23	Seal-oil, 15x25x7	1	91521501	91521501	91521501	油封
24	Seat-tappet	1	1121601804	1121601804	1121601804	自動停止挺桿座
25	Shaft-tappet	1	1121601902	1121601902	1121601902	止動心軸
26	Screw-hexa. socket headless set, M6xP1.0x16L	2				固定螺絲
27	Tappet	1	1121602007	1121602007	1121602007	自動停止挺桿
28	Nut, M8xP1.25	1				螺帽
29	Screw-hexa. socket headless set, M8xP1.25x30L	1	91102080300005	91102080300005	91102080300005	固定螺絲
30	Screw-hexa. socket headless set, M6xP1.0x40L	1	91120640	91120640	91120640	固定螺絲
31	Set screw, M6x40	1				車削止付
32	Nut, M6xP1.0	2				
33	Screw-oil leakage, PT1/4	1	92590601	92590601	92590601	油塞
34	Seal-oil, 32x42x10	2	91523210	91523210	91523210	油封
35	Bushing	2	1210901804	1210901804	1210901804	軸襯
36	Sleeve-feed rod	1	1210901902	1210901902	1210901902	自動進刀軸套

Item No.	Part Name	Amt. Used	Type : 16 Part No.	Type : 18 Part No.	Type : 20 Part No.	名稱
37	Key-square , 6x6x42L	1	91610611	91610611	91610611	雙圓平行鍵
38	Key-square , 6x6x12L	1	91610601	91610601	91610601	雙圓平行鍵
39	Gear	1	1210903200	1210903200	1210903200	齒輪
40	Seat-worm	1	1210903308	1210903308	1210903308	蝸桿座
41	Shaft-worm	1	1210903406	1210903406	1210903406	蝸桿心軸
42	Bearing-thrust , 2904	2				止推軸承
43	Worm gear	1	1210902007	1210902007	1210902007	蝸桿
44	Washer-lock , 20	1				太陽墊圈
45	Nut	1				蝸桿心軸螺帽
46	Screw-hexa. socket head cap , M6xP1.0x12L	8	91110612	91110612	91110612	六角承窩螺絲
47	Spring , ϕ 1x10x60L (right)	1	1210905400	1210905400	1210905400	彈簧
	(left)	1	1210905508	1210905508	1210905508	
48	Block-safe device (right)	1	1210901000	1210901000	1210901000	安全塊
	(left)	1	1210900905	1210900905	1210900905	
49	Pin , 5x18L	2	92030525	92030525	92030525	彈簧銷
50	Pin (right)	1	1210901206	1210901206	1210901206	撥動軸
	(left)	1	1210901108	1210901108	1210901108	
51	Shaft-auto feed (right)	1	1210901206	1210901206	1210901206	撥動軸
52	Collar (right)	1	1210901206	1210901206	1210901206	撥動軸
53	Ring-O , P16	2	9151P016	9151P016	9151P016	O型環
54	Cover	1	1210903602	1210903602	1210903602	軸蓋
55	Hub (right)	1	1210901402	1210901402	1210901402	撥桿軸套
	(left)	1	1210901304	1210901304	1210901304	
56	Spring washer , M8	1				彈簧華司
57	Screw-hexa. socket head cap , M8xP1.25x12L	1				
58	Snap ring , S10	1				
59	Lever	1	1210903700	1210903700	1210903700	自動停止槓桿
60	Spring washer , M12	1	91420012	91420012	91420012	彈簧墊圈
61	Screw	1	1210903808	1210903808	1210903808	槓桿心軸
62	Screw-hexa. socket head cap , M5xP0.8x20L	1				六角承窩螺絲
63	Spring	1	1210905606	1210905606	1210905606	彈簧
64	Spacer	1	1210903906	1210903906	1210903906	密封塊
65	Bearing-ball , 6005V	1	91301012	91301012	91301012	滾珠軸承
66	Worm-wheel	1	1210902105	1210902105	1210902105	蝸輪
67	Wheel-friction	1	1210902203	1210902203	1210902203	離合齒輪
68	Key-square , 7x7x12L	1				雙圓平行鍵
69	Shaft-worm wheel	1	1210904001	1210904001	1210904001	離合器心軸
70	Pin	1	1210904109	1210904109	1210904109	墊圈擋塊
71	Spring-compressing	1	1210905302	1210905302	1210905302	彈簧
72	Washer	1	1210904207	1210904207	1210904207	墊片
73	Screw-hexa. socket headless set	1				固定螺絲
74	Bearing-ball , 6204	1	91301018	91301018	91301018	滾珠軸承
75	Cover		1210904305	1210904305	1210904305	離合器
76	Snap ring , S20	2	9171S020	9171S020	9171S020	扣環
77	Gear	1	1210902301	1210902301	1210902301	齒輪

APRON ASSEMBLY

Item No.	Part Name	Amt. Used	Type : 16 Part No.	Type : 18 Part No.	Type : 20 Part No.	名稱
78	Shaft-cross feed	1	1210904403	1210904403	1210904403	縱橫變換軸
79	Set (right)	1	1210901608	1210901608	1210901608	變換軸套
	(left)	1	1210901500	1210901500	1210901500	
80	Shaft-lever	1	1210904501	1210904501	1210904501	縱橫變換齒輪
81	Lever	1				
82	Sleeve-lever	1				
83	Screw-hexa. socket headless set , M4xP0.7x10L	1				固定螺絲
84	Pinion-rack	1	1210904707	1210904707	1210904707	中間軸
85	Key-square , 6x6x20L	1	91610605	91610605	91610605	雙圓平行鍵
86	Bearing-middle , NK20/22	1	91311001	91311001	91311001	滾針軸承
87	Screw-hexa. socket headless set , M6xP1.0x10L	1	91120610	91120610	91120610	固定螺絲
88	Collar	1	1210904805	1210904805	1210904805	固定圈
89	Pin-spring , 6x36L	1	92030636	92030636	92030636	彈簧銷
90	Gear	1	1210904903	1210904903	1210904903	中間軸齒輪
91	Bearing-ball , 6003	1	91301005	91301005	91301005	滾珠軸承
92	Cover	1	1210905008	1210905008	1210905008	軸套
93	Pinion-handwheel		1210905106	1210905106	1210905106	手輪心軸
94	Key-square , 6x6x25L	1	91610605	91610605	91610605	雙圓平行鍵
95	Bearing-ball , 6004V	1	91301008	91301008	91301008	滾珠軸承
95-1	Bearing-ball , 6004Z	1	91301007	91301007	91301007	
96	Seat		1210905204	1210905204	1210905204	軸承套
97	Screw-hexa. socket head cap , M6xP1.0x30L	4	91110630	91110630	91110630	六角承窩螺絲
99	Washer	1	1210701608	1210701608	1210701608	墊塊
100	Washer-wave type	1				浪型墊圈
101	Dial-rack	1	1220900202	1220900202	1220900202	刻度環
102	Handwheel	1	1122101705	1122101705	1122101705	手輪
103	Handle	1	1121102002	1121102002	1121102002	手柄
104	Washer-lock	1	1122101901	1122101901	1122101901	鎖緊墊片
105	Screw-hexa. socket head cap , M8xP1.25x20L	1	91110820	91110820	91110820	六角承窩螺絲
106	Dial-thread chasing (in 4 parts)	1	1003514708	1003514708	1003514708	指示表規
	parts)	1	1003502404	1003502404	1003502404	
	parts)	1	1003514904	1003514904	1003514904	
107	Pin	1				
108	Seat-dial shaft	1	1003514502	1003514502	1003514502	車牙表規座
109	Screw-hexa. socket head cap , M10xP1.5x65L	1	91111065	91111065	91111065	六角承窩螺絲
110	Gear (in 16T)	1	1003514600	1003514600	1003514600	齒輪
	(mm 11T)	1	1003502502	1003502502	1003502502	
	(mm 13T)	1	1003502600	1003502600	1003502600	
	(mm 14T)	1	1003514806	1003514806	1003514806	
	(mm 15T)	1	1003502708	1003502708	1003502708	
	(mm 18T)	1	1003502806	1003502806	1003502806	
111	Washer-spring , 10	1				彈簧墊圈
112	Nut , M10xP1.5	1	91210010	91210010	91210010	螺帽

Item No.	Part Name	Amt. Used	Type : 16 Part No.	Type : 18 Part No.	Type : 20 Part No.	名稱
113	Snap ring , S30	1	9171S030	9171S030	9171S030	扣環
114	Seat-switch	1	1210701706	1210701706	1210701706	開關座
115	Key-square , 6x8x25L	1	91610610	91610610	91610610	雙圓平行鍵
116	Screw-hexa. socket head cap , M8xP1.25x16L	2	91110816	91110816	91110816	六角承窩螺絲
117	Bracket	1	1210701804	1210701804	1210701804	啓動槓桿座
118	Screw-lock	2	1210701902	1210701902	1210701902	特殊固定螺栓
119	Screw-hexa. socket headless cap , M8xP1.25x8L	1	1210702007	1210702007	1210702007	停止定位銷
120	Seat-lever	1	1210702105	1210702105	1210702105	啓動桿
121	Screw-hexa. socket headless set , M8xP1.25x8L	2	91120808	91120808	91120808	固定螺絲
122	Spring	1				彈簧
123	Lever	1	1210702203	1210702203	1210702203	把手
124	Sleeve-lever	1	1122103601	1122103601	1122103601	電木把手

MACHINERYHOUSE

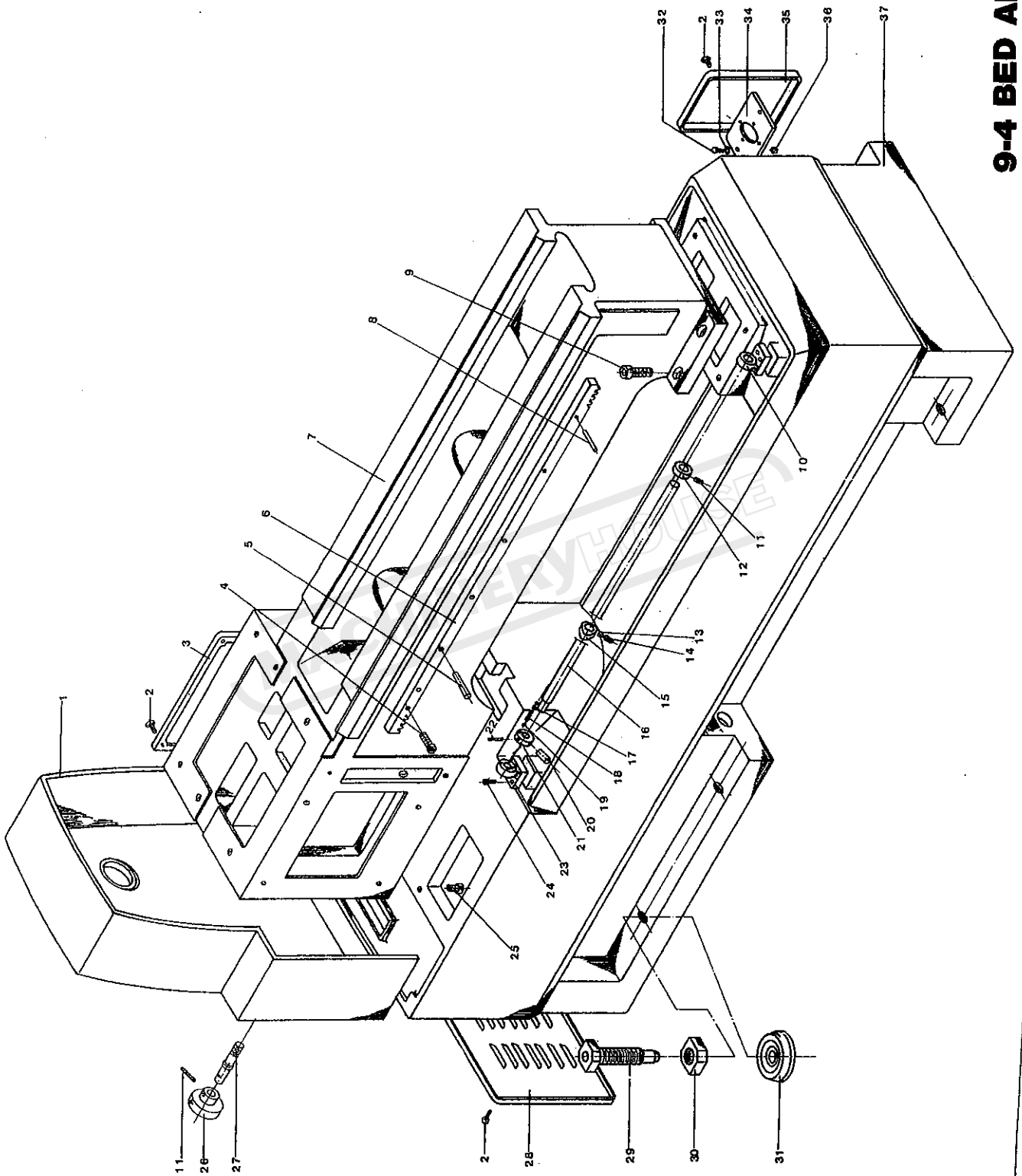

9-4 BED AND BASE

BED AND BASE ASSEMBLY

Item No.	Part Name	Amt. Used	Type : 16 Part No.	Type : 18 Part No.	Type : 20 Part No.	名稱
1	Cover-end	1	1221600201	1221600103	1321600301	主軸側蓋
2	Screw-cross-recessed head , M6xP1.0x20L	12				十字埋頭螺絲
3	Cover-electric box	1	1122102006	1122102006	1122102006	配電箱板蓋
4	Screw-hexa. socket head cap , M6xP1.0x25L	10	91110625	91110625	91110625	六角承窩螺絲
5	Pin-taper , 6x36	2				彈簧銷
6	Rack (5 feet)	1	1210701000	1210701000	1210701000	齒條
	(6 feet , right)	1	1220700604	1220700604	1220700604	
	(6 feet , left)	1	1220700506	1220700506	1220700506	
	(8 feet)	1	1230700509	1230700509	1230700509	
	(10 feet)	1	1240700502	1240700502	1240700502	
7	Bed (5 feet)	1	1210100101	1210100101	1210100101	床身
	(6 feet)	1	1220100104	1220100104	1220100104	
	(8 feet)	1	1230100107	1230100107	1230100107	
	(10 feet)	1	1240100100	1240100100	1240100100	
8	Pin-taper , 6x36	2	92030636	92030636	92030636	彈簧銷
9	Screw-hexa. socket head cap , M16xP2.0x45L	4	91111645	91111645	91111645	六角承窩螺絲
10	Supporter-shaft	1	1122102104	1122102104	1122102104	右軸台
11	Screw-hexa. socket headless set , M6xP1.0x10L	2	91120610	91120610	91120610	固定螺絲
12	Collar	1	1122102202	1122102202	1122102202	停止軸套環
13	Shoe-brass	4	1122102300	1122102300	1122102300	停止凸輪墊塊
14	Screw-hexa. socket headless set , M6xP1.0x6L	1				固定螺絲
15	Cam-auto feed stopping	4	1122102408	1122102408	1122102408	自動進刀停止凸輪
16	Shaft-auto stopping (5 feet)	1	1212100109	1212100109	1212100109	停止軸
	(6 feet)	1	1222100308	1222100308	1222100308	
	(8 feet)	1	1232100105	1232100105	1232100105	
	(10 feet)	1	1242100108	1242100108	1242100108	
17	Screw-hexa. socket headless set , M8xP1.25x8L	1	91120808	91120808	91120808	固定螺絲
18	Spring , 1x6x8L	1	91910610	91910610	91910610	彈簧
19	Ball-steel , 1/4"	1	91820104	91820104	91820104	鋼珠
20	Lever-turning shaft	4	1122103807	1122103807	1122103807	停止轉輪把手
21	Collar	1	1122103905	1122103905	1122103905	自動停止轉輪
22	Screw-hexa. socket headless set , M8xP1.25x10L	1	91120810	91120810	91120810	固定螺絲
23	Supporter-shaft	1	1122102604	1122102604	1122102604	左軸台
24	Screw-hexa. socket head cap , M8xP1.25x16L	4	91110816	91110816	91110816	六角承窩螺絲
25	Screw-hexa. socket head cap , M16xP2.0x55L	8	91111655	91111655	91111655	六角承窩螺絲
26	Plug	1	1122102702	1122102702	1122102702	側蓋鎖緊螺栓塞
27	Bolt-lock	1				
28	Cover-motor seat	2	1122100806	1122100806	1122100806	床頭馬達孔蓋板
29	Bolt-set machine	6	1122102800	1122102800	1122102800	固定螺栓
30	Nut-lock	6	1122102800	1122102800	1122102800	固定螺栓螺帽
31	Block-leveling	6	1003501809	1003501809	1003501809	墊塊

BED AND BASE ASSEMBLY

Item No.	Part Name	Amt. Used	Type : 16 Part No.	Type : 18 Part No.	Type : 20 Part No.	名稱
32	Bolt-hexa. head , W1/4"x25	2				六角頭螺絲
33	Washer , W5/8"	2	91401051600003	91401051600003	91401051600003	墊圈
34	Seat-coolant pump (5 · 6 feet)	1	1210100503	1210100503	1210100503	冷卻泵浦座
	(8 feet)	1	123100509	123100509	123100509	
	(10 feet)	1	1240100502	1240100502	1240100502	
35	Cover-coolant motor seat	1	1005000403	1005000403	1005000403	泵浦孔蓋板
36	Nut-lock , W1/4"	2				螺帽
37	Base (5 feet)	1	1210100209	1210100209	1210100209	底座
	(6 feet)	1	1220100202	1220100202	1220100202	
	(8 feet)	1	1230100205	1230100205	1230100205	
	(10 feet)	1	1246100208	1246100208	1246100208	

MACHINERYHOUSE

9-5 BRAKE SYSTEM

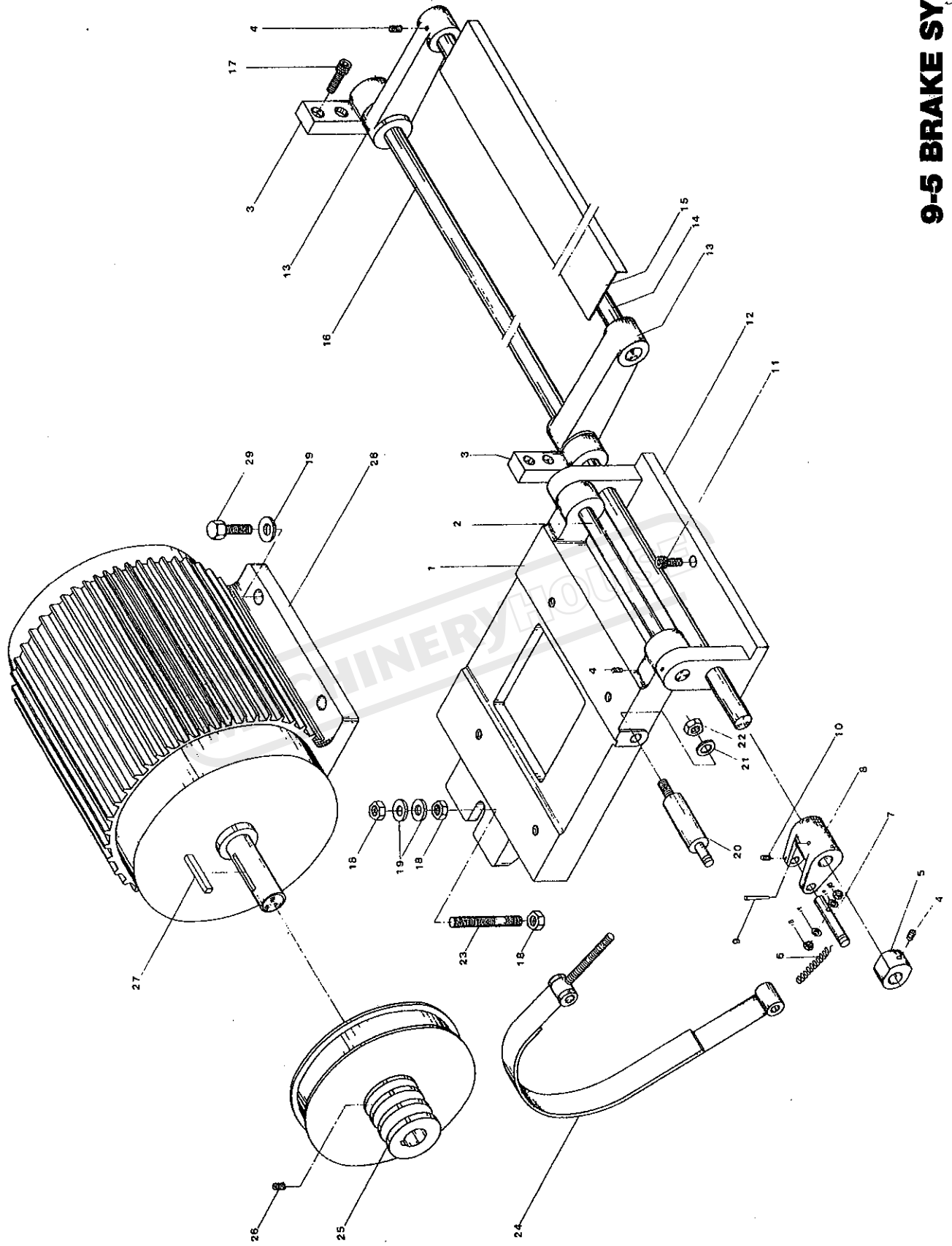

BRAKE SYSTEM ASSEMBLY

Item No.	Part Name	Amt. Used	Type : 16 Part No.	Type : 18 Part No.	Type : 20 Part No.	名稱
1	Seat-motor	1	1210400106	1210400106	1210400106	馬達底板
2	Shaft-motor seat	1	1210400204	1210400204	1210400204	基座樞軸
3	Block	2	1210100601	1210100601	1210100601	軸台
4	Screw-hexa. socket headless set , M6xP1.0x15L	4	91102060160003	91102060160003	91102060160003	固定螺絲
5	Cam	1	1210400606	1210400606	1210400606	凸輪
6	Spring	1	1210400302	1210400302	1210400302	彈簧
7	Shaft-brake	1	1210400704	1210400704	1210400704	煞車帶插銷
8	Arm-brake	1	1210400802	1210400802	1210400802	制動搖臂
9	Pin-taper , 4"x38L	1				推拔銷
10	M6xP1.0x10L	1				固定螺絲
11	Screw-hexa. socket head cap , M10xP1.5x20L	3	91111020	91111020	91111020	六角承窩螺絲
12	Bracket-motor seat	1	1210100709	1210100709	1210100709	馬達基座托架
13	Bracket-pedal	2	1210400900	1210400900	1210400900	踏板支架
15	Pedal-brake (5 feet)	1	1210400508	1210400508	1210400508	踏板
	(6 feet)	1	1220400109	1220400109	1220400109	
	(8 feet)	1	1230400102	1230400102	1230400102	
	(10 feet)	1	1240400105	1240400105	1240400105	
16	Shaft-pedal bracket (5 feet)	1	1210100405	1210100405	1210100405	制動踏板軸
	(6 feet)	1	1220100300	1220100300	1220100300	
	(8 feet)	1	1230100401	1230100401	1230100401	
	(10 feet)	1	1240100404	1240100404	1240100404	
17	Screw-hexa. socket head cap , M8xP1.25x25L	4	91110825	91110825	91110825	六角承窩螺絲
18	Nut , M16	5	91210016	91210016	91210016	螺帽
19	Washer , M16	8	91410016	91410016	91410016	平墊圈
20	Bolt-adjusting	1	1210401005	1210401005	1210401005	調整螺栓固定銷
21	Washer , M12	1	91410012	91410012	91410012	平墊圈
22	Nut , M12	1	91210012	91210012	91210012	螺帽
23	Bolt-adjusting	1	1210400400	1210400400	1210400400	調整螺栓
24	Belt-brake (5HP , 15HP)	1	1003519605	1003519605	1003519605	煞車帶
	(7.5HP , 10HP)	1	1003519703	1003519703	1003519703	
25	Belt pulley (5HP/60HZ)	1	1000400805	1000400403	1000400403	馬達皮帶輪
	(7.5HP/60HZ)	1	1000400501	1000400109	1000400109	
	(5HP/50HZ)	1	1000400609	1000400207	1000400207	
	(7.5HP/50HZ)	1	1000400707	1000400305	1000400305	
26	Screw-hexa. socket headless set , M8xP1.25x8L	1	91120608	91120608	91120608	固定螺絲
27	Key , 8x7.5x40 (5HP)	1				雙圓平行鍵
	10x8x65 (7.5HP)	1				
	(10HP)	1				
	12x8x80 (15HP)	1				
28	Motor	1				馬達
29	Bolt-hexa. head , M10x30L	4				六角鋼螺絲

9-6 CARRIAGE AND CROSSFEED

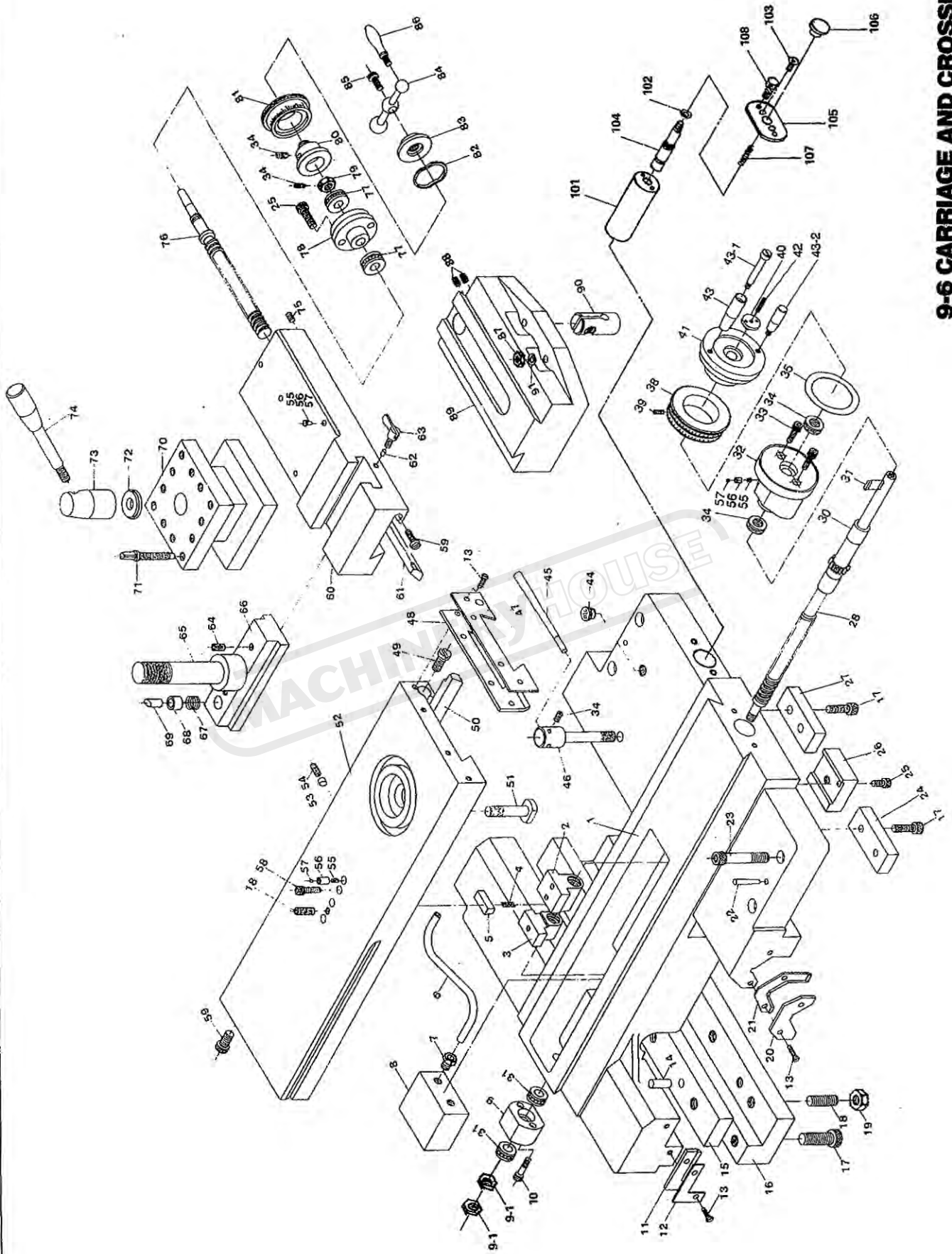

CARRIAGE AND CROSSFEED ASSEMBLY

Item No.	Part Name	Amt. Used	Type : 16 Part No.	Type : 18 Part No.	Type : 20 Part No.	名稱
1	Carriage	1	1220800109	1220800109	1220800109	滑座本體
2	Nut-crossfeed	1				螺帽
3	Nut-crossfeed	1				螺帽
4	Spring , 0.3x5x15L	1				彈簧
5	Shim-crossfeed nut	1	1120800901	1120800901	1120800901	楔
6	Pipe-lubrication oil	1				
7	Nut-copper	1				
8	Conveyor-oil	1	1120801006	1120801006	1120801006	分油器
9	Cap-crossfeed screw	1	1120801104	1120801104	1120801104	托架
9-1	Nut-hexa. head , M12xP1.25	1				六角螺帽
10	Screw-hexa. socket head cap , M6xP1.0x10L	2	91110610	91110610	91110610	六角承窩螺絲
11	Wiper-rear	1	1122100100	1122100100	1122100100	右後防塵油封
12	Case-wiper , rear	1	1122100306	1122100306	1122100306	後防塵油封固定片
13	Screw-cross-recessed , M4xP0.7x10L	8	91140410	91140410	91140410	十字圓頭螺絲
14	Pin	2				直銷
15	Gib	1	1220800207	1220800207	1220800207	埃條
16	Holder-gib	1	1220800403	1220800403	1220800403	後扁栓
17	Screw-hexa. socket head cap , M8xP1.25x20L	2	91110820	91110820	91110820	六角承窩螺絲
18	Screw-hexa. socket headless set , M8xP1.25x20L	5	91120820	91120820	91120820	固定螺絲
19	Nut , M8xP1.25	4				螺帽
20	Case-wiper , front	1	1122100404	1122100404	1122100404	前防塵油封固定片
21	Wiper-front	1	1122100100	1122100100	1122100100	防塵油封
22	Pin-taper , 6#x75L	2	1210700503	1210700503	1210700503	推拔銷
23	Screw-hexa. socket head cap , M10xP1.5x70L	4				六角承窩螺絲
24	Gib-left-front	1	1120801202	1120801202	1120801202	左前扁栓
25	Screw-hexa. socket head cap , M6xP1.0x20L	3	91120620	91120620	91120620	固定螺絲
26	Clamp-carriage	1	1120801300	1120801300	1120801300	滑座夾緊塊
27	Gib-right-front	1	1120801408	1120801408	1120801408	右前扁栓
28	Screw-crossfeed (10TPI, in)	1	1000800501	1000800501	1000800501	導螺桿
	(4MM, mm)	1	1000800109	1000800109	1000800109	
29	Pin-spring , 5x30L	1	92030530	92030530	92030530	彈簧銷
30	Pinion-crossfeed (local)	1		1220800501	1320800209	齒輪軸
	(export)	1		1220800609	1320800307	
31	Square key , 5x5x15L	1	91303001	91303001	91303001	止推軸承
32	Bracket	1	1120800107	1120800107	1120800107	托架
33	M8xP1.25x40L	2	91110840	91110840	91110840	六角承窩螺絲
34	Bearing-thrust , 6x6	2	91120606	91120606	91120606	固定螺絲
35	Washer-wave type , 6210	2	91440001	91440001	91440001	浪型墊圈
36	Screw-hexa. socket head cap headless set , M6xP1.0x10	1	91120610	91120610	91120610	固定螺絲
37	Clutch-dial	1	1120802807	1120802807	1120802807	測微規基座
38	(10TPI/left/export)	1	1000803502	1000803502	1000803502	測微規套環
	(4MM/left/export)	1	1000802603	1000802603	1000802603	

CARRIAGE AND CROSSFEED ASSEMBLY

Item No.	Part Name	Amt. Used	Type : 16 Part No.	Type : 18 Part No.	Type : 20 Part No.	名稱
39	Screw-hexa. socket headless set , M6xP1.0x15L	1				六角承窩螺絲
40	Set screw	1	1120803000	1120803000	1120803000	測微規基座
41	Handle-wheel (local)	1	1120802601	1120802601	1120802601	手柄
	(export)	1	1120802709	1120802709	1120802709	
42	Screw -adjusting , M6xP1.0x30L	1				調整螺栓
43	Knob-handle (local)	1	1120803206	1120803206	1120803206	手柄
	(export)	1	1120803304	1120803304	1120803304	
43-1	Screw-handle (export)	1	1120803500	1120803500	1120803500	螺絲
43-2	Knob-handle	1	1120803402	1120803402	1120803402	握把
44	Plug-oil inlet	1	1122103405	1122103405	1122103405	油塞
45	Lever	1	1120801506	1120801506	1120801506	固定把手
46	Screw-carriage clamp	1	1120800607	1120800607	1120800607	固定螺栓
47	Case-wiper	1				
48	Wiper	1	1222100102	1222100102	1222100102	橫滑座防塵油封
49	Screw-adjusting	1	1120801604	1120801604	1120801604	調整螺栓
50	Gib	1	1220800305	1220800305	1220800305	嵌條
51	Bolt	4	1120800509	1120800509	1120800509	特殊螺帽
52	Cover-cross sliding	1	1430800802	1430800802	1430800802	橫滑座
53	Shoe-clamp	1	1220800707	1220800707	1220800707	鎖緊銷
54	Screw-hexa. socket headless cap , M6xP1.0x20L	1	91120620	91120620	91120620	固定螺絲
55	Ball-steel , 1/4"	1				銅入珠
56	Ball-steel , 1/4"	1				銅入珠
57	Ball-steel , 1/4"	1				銅入珠
58	Screw-hexa. socket head cap , M6xP1.0x3	3				六角承窩螺絲
59	Screw-gib	2	112081702	112081702	112081702	調整螺栓
60	Compound rest (local , mm)	1	1000804901	1000805300	1000805702	刀具滑座
	(export , in)	1	1000811504	1000805604	1000806003	
61	Gib-compound rest	1				
62	Shoe-clamp	1	1220800707	1220800707	1220800707	鎖緊銷
63	Screw-clamp	1				
64	Screw-hexa. socket headless cap , M8xP1.25x10L	4				
65	Shaft-tool post	1				
65-1	Shaft-tool post	1				
66	Block-tee	1				
67	Spring , 1x8x20L	1				
68	Sleeve	1				
69	Button	1				
70	Tool post-square (in)	1	1003512802	1003512606	1003512606	四方刀架
	(mm)	1	1003512704	1003512508	1003512508	
71	Screw-square head	1	1000804107	1000804107	1000804107	刀架螺絲
72	Washer	1				
73	Knob-lever	1	1000810605	1000810605	1000810605	鎖緊輪
74	Lever	1	1003521301	1003521301	1003521301	煙斗
75	Screw-gib , M8xP1.25x30L	1				

CARRIAGE AND CROSSFEED ASSEMBLY

Item No.	Part Name	Amt. Used	Type : 16 Part No.	Type : 18 Part No.	Type : 20 Part No.	名稱
76	Screw-compound rest	1	1000803904	1000803904	1000803904	船座導螺桿
77	Bearing-thrust , 51102	2				
78	Seat-compound rest screw	1				
79	Nut	1				
80	Collar	1				
81	Dial-compound rest	1	1000820003	1000820003	1000820003	刻度環
82	Washer-wave type	1				
83	Nut	1				螺絲
84	Handle	1				
85	Screw-hexa. socket head cap , M6xP1.0x16L	1	91110616	91110616	91110616	六角承窩螺絲
86	Knob-handle	1				
87	Nut , M10xP1.5	4				螺絲
88	Screw-hexa. socket headless set , M8xP1.25x8L	2				
89	Swivel	1				
90	Nut-compound rest screw	1				
91	Spring washer , M10	4				
101	Body-pump	1	1120801800	1120801800	1120801800	泵浦本體
102	Ring-O , P10	1				O型環
103	Screw , M5xP0.8x12L	2				六角孔埋頭螺絲
104	Rod-pump	1	1120801908	1120801908	1120801908	活塞桿
105	Stopper	1	1120802003	1120802003	1120802003	固定板
106	Plug	1		1120802101	1120802101	把手
107	Spring-compressing , ϕ 1.2x10x63L	1				彈簧
108	Screw-hexa. socket head cap , M6xP1.0x16L	2	1120802209	1120802209	1120802209	十字圓頭螺絲

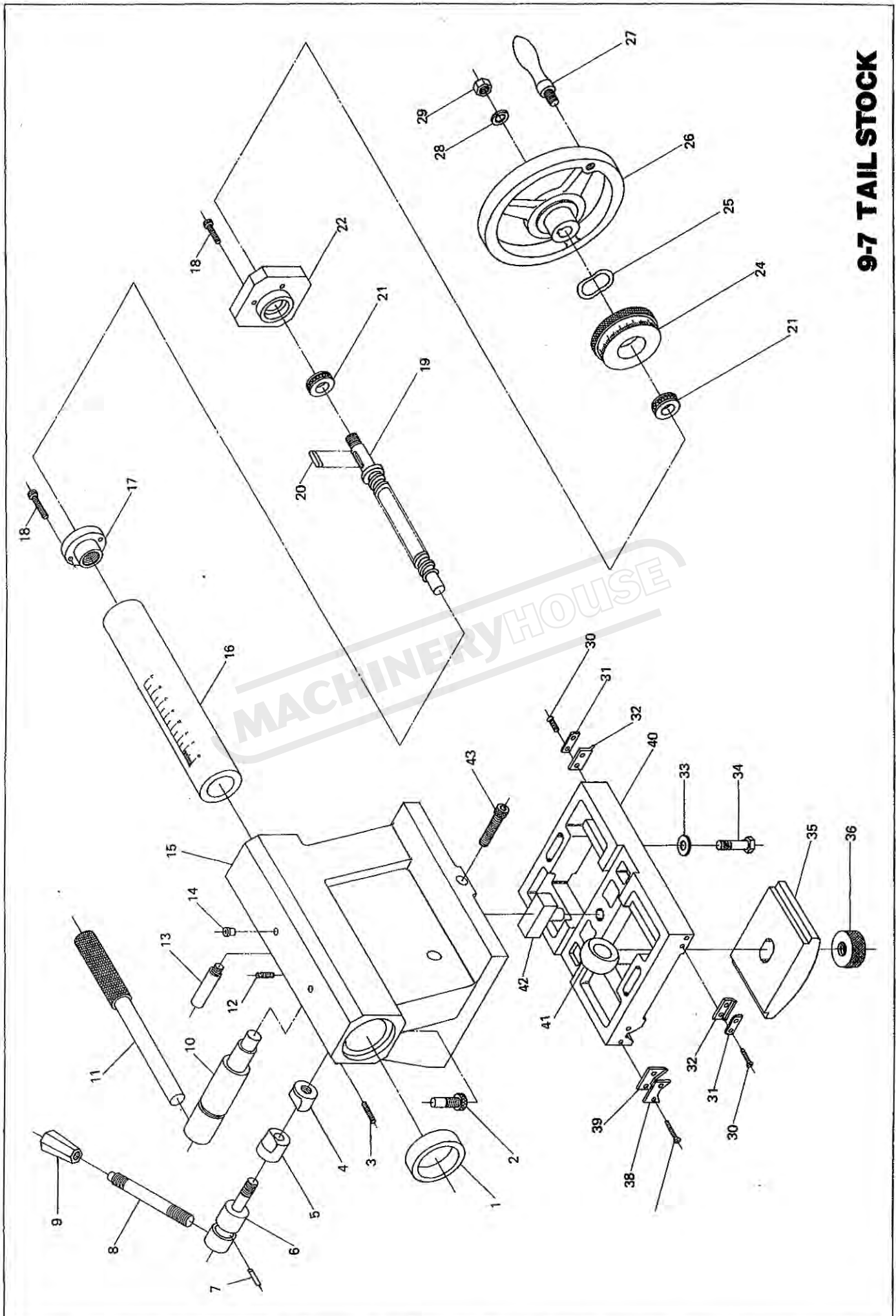

9-7 TAIL STOCK

TAILSTOCK ASSEMBLY

Item No.	Part Name	Amt. Used	Type : 16 Part No.	Type : 18 Part No.	Type : 20 Part No.	名稱
1	Seal-oil, TC68x90x12	1	91526801	91526801	91526801	油封
2	Screw-hexa. socket head cap , M8xP1.25x10L	1	1121100802	1121100802	1121100802	六角承窩螺絲
3	Screw-hexa. socket headless set , M6xP1.0x10L	1	91120610	91120610	91120610	固定螺絲
4	Block-clamp	1	1121101005	1221100706	1221100706	鎖緊軸套
5	Block-clamp	1	1121101005	1221100706	1221100706	鎖緊軸套
6	Shaft-clamp spindle	1	1121101103	1221100804	1221100804	鎖緊螺栓
7	Pin , 5x12	1				彈簧銷
8	Lever	1	1121102100	1121102100	1121102100	手柄
9	Sleeve-lever	1	1120207400	1120207400	1120207400	電木把手
10	Shaft-clamp bottom	1	1121101201	1221100902	1221100902	偏心軸柄
11	Lever	1	1121101201	1221100902	1221100902	偏心軸柄
12	M6xP1.0x20L	1	91120620	91120620	91120620	固定螺絲
13	Screw-brake	1	1121102306	1121102306	1121102306	制動銷
14	Plug-oil	3				銅入珠
15	Body-tailstock	1	1121100106	1221100108	1221100108	尾座本體
16	Spindle-tang slot	1	1121101309	1221101007	1221101007	套筒
17	Cap-spindle	1				銅螺帽
18	Screw-hexa. socket head cap , M6xP1.0x12L	3	91110612	91110612	91110612	六角承窩螺絲
19	Screw-spindle feed (in)	1		1221100304	1221100304	螺旋軸
	(mm)	1		1221100402	1221100402	
20	Key-square , 6x6x25	1	91610606	91610606	91610606	雙圓平行鍵
21	Bearing-thrust , 51204	2				止推軸承
22	Cap-body end	1	1121101407	1221101105	1221101105	尾座後護蓋
23	Screw-hexa. socket head cap , 96xP1.0x25L	4				
24	Dial-feed (in)	1	1121100508	1221100500	1221100500	刻度環
	(mm)	1	1121100606	1221100608	1221100608	
25	Washer-wave type , 6205	1	91440002	91440002	91440002	浪型墊圈
26	Handwheel	1	1121100900	1121100900	1121100900	手輪
27	Knob	1	1121102002	1121102002	1121102002	握把
28	Washer , 1/2"	1	9141S001	9141S001	9141S001	平墊圈
29	Nut , 1/2-20UNF	1	9125S001	9125S001	9125S001	特殊耐龍鎖緊螺帽
30	Screw-cross-recessed , M4xP0.7x12L	4				十字圓頭螺絲
31	Case-wiper	2				前防塵油封固定片
32	Wiper	2				防塵油封
33	Washer-flat , M10	2	91410010	91410010	91410010	平墊圈
34	Bolt-clamp , M10xP1.5x75L	2				六角頭螺絲
35	Clamp	1				制動塊
36	Washer	1				螺帽
38	Case	1				後防塵油封固定片
39	Wiper	1				防塵油封
40	Bottom-tailstock	1				尾座底板
41	Bolt-clamp	1				環首螺栓
42	Block-adjusting	1				左右調整塊

TAILSTOCK ASSEMBLY

Item No.	Part Name	Amt. Used	Type : 16 Part No.	Type : 18 Part No.	Type : 20 Part No.	名稱
43	Screw-hexa. socket , M10xP1.5x80L	2	91111080	91111080	91111080	六角承窩螺絲

MACHINERYHOUSE

9-8 STEADY REST

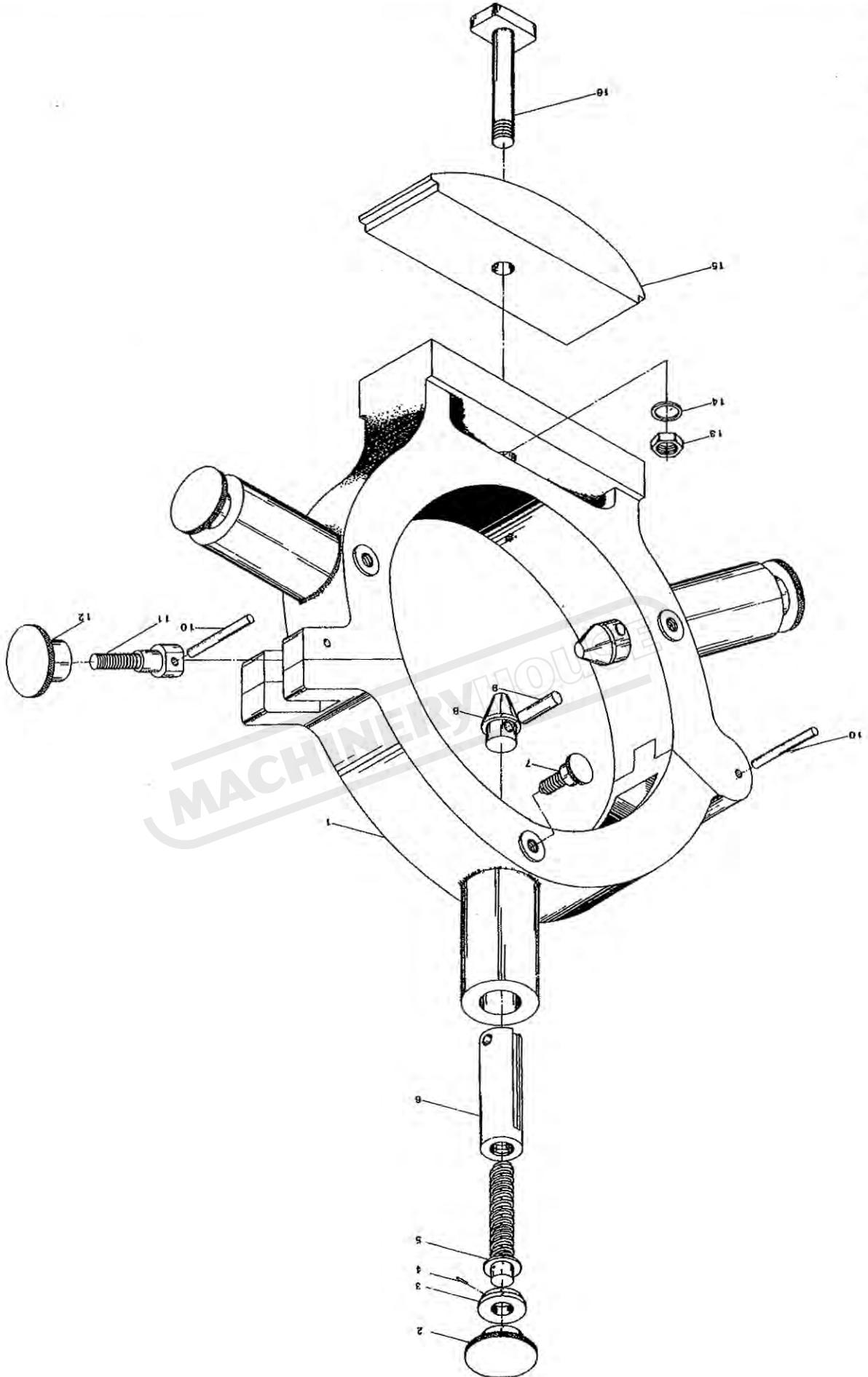

STEADY REST

Item No.	Part Name	Amt. Used	Type : 16 Part No.	Type : 18 Part No.	Type : 20 Part No.	名稱
1	Steady-rest	3				中心架
2	Plug-lead screw	3				
3	Cap , 6x52L	12				
4	Pin	3				
5	Lead-screw	3				
6	Nut-lead screw	1				
7	Screw-fixed	3				
8	Jaw	3				
9	Pin-fixed	3				
10	Pin , 9x25L	2				
11	Screw	1				
12	Plug	1				
13	Nut , W5/8"	1				
14	Washer	1				
15	Block-clamp	1	1003500204	1003500204	1003500204	固定架制動塊
16	Bolt	1	1003500400	1003500400	1003500400	制動塊螺栓
	(6" 套銅)		1003519203	1003501103		中心架
	(6" 軸承)		1003519301	1003501201		
	(9" 套銅)			1003501309	1003501505	
	(9" 軸承)			1003501407	1003501603	

9-9 FOLLOW REST

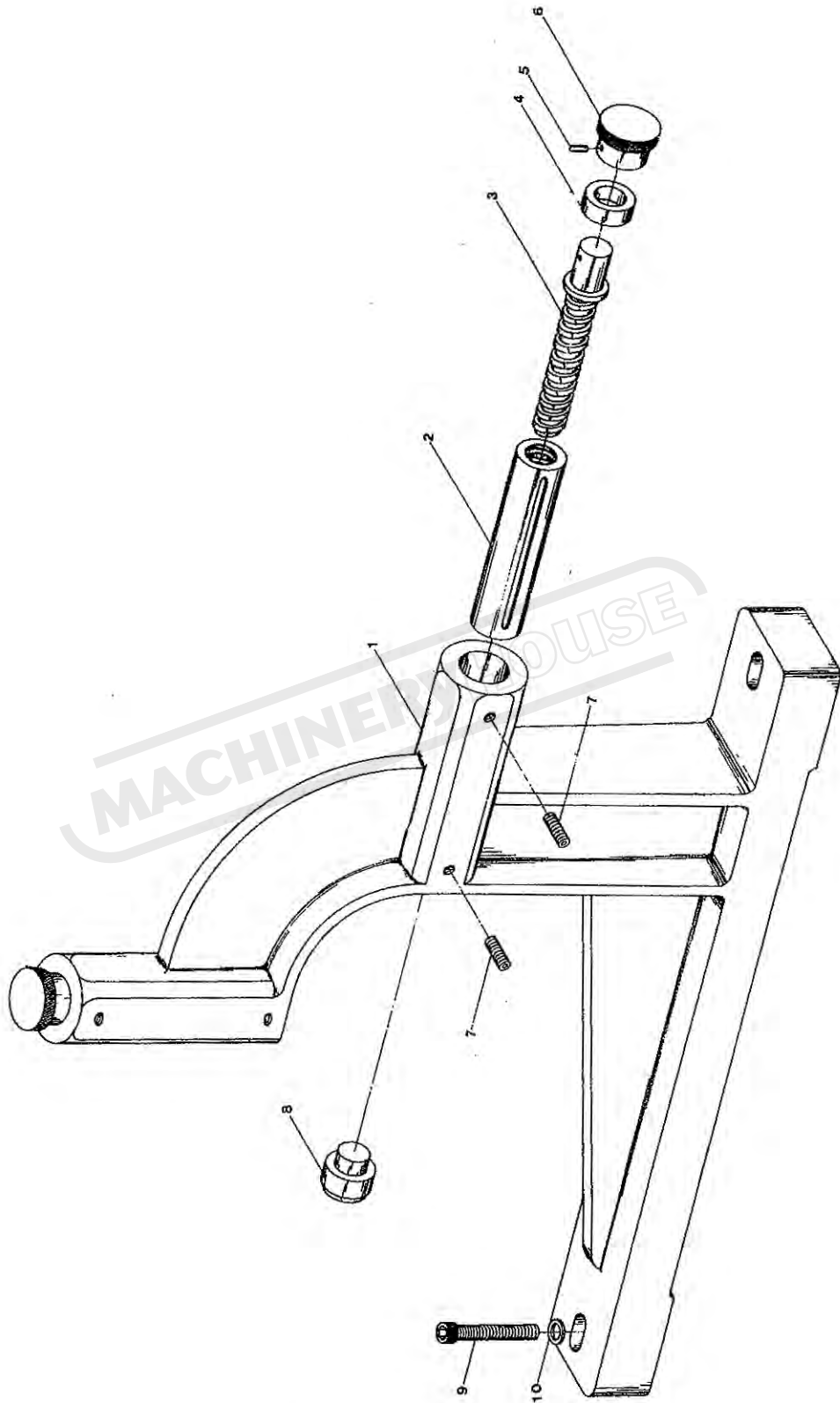

FOLLOW REST ASSEMBLY

Item No.	Part Name	Amt. Used	Type : 16 Part No.	Type : 18 Part No.	Type : 20 Part No.	名稱
1	Body-follow rest	1				跟刀架
2	Nut-lead screw	2				
3	Lead-screw	2				
4	Collar	2				
5	Pin , 4x25L	2				
6	Plug-lead screw	2				
7	Screw-hexa. socket headless cap , M8xP1.25x10L	4				
8	Shoe	2				
9	Screw-hexa. socket head cap , M10xP1.5x30L	2	91111030	91111030	91111030	六角承窩螺絲
10	Washer					
	(6" 套銅)		10035019409	1003503107		跟刀架
	(6" 軸承)		100352700	100352710		
	(9" 套銅)			1003503107	1003503205	
	(9" 軸承)			100352710	100352720	

MACHINERYHOUSE

9-10 COOLANT SYSTEM

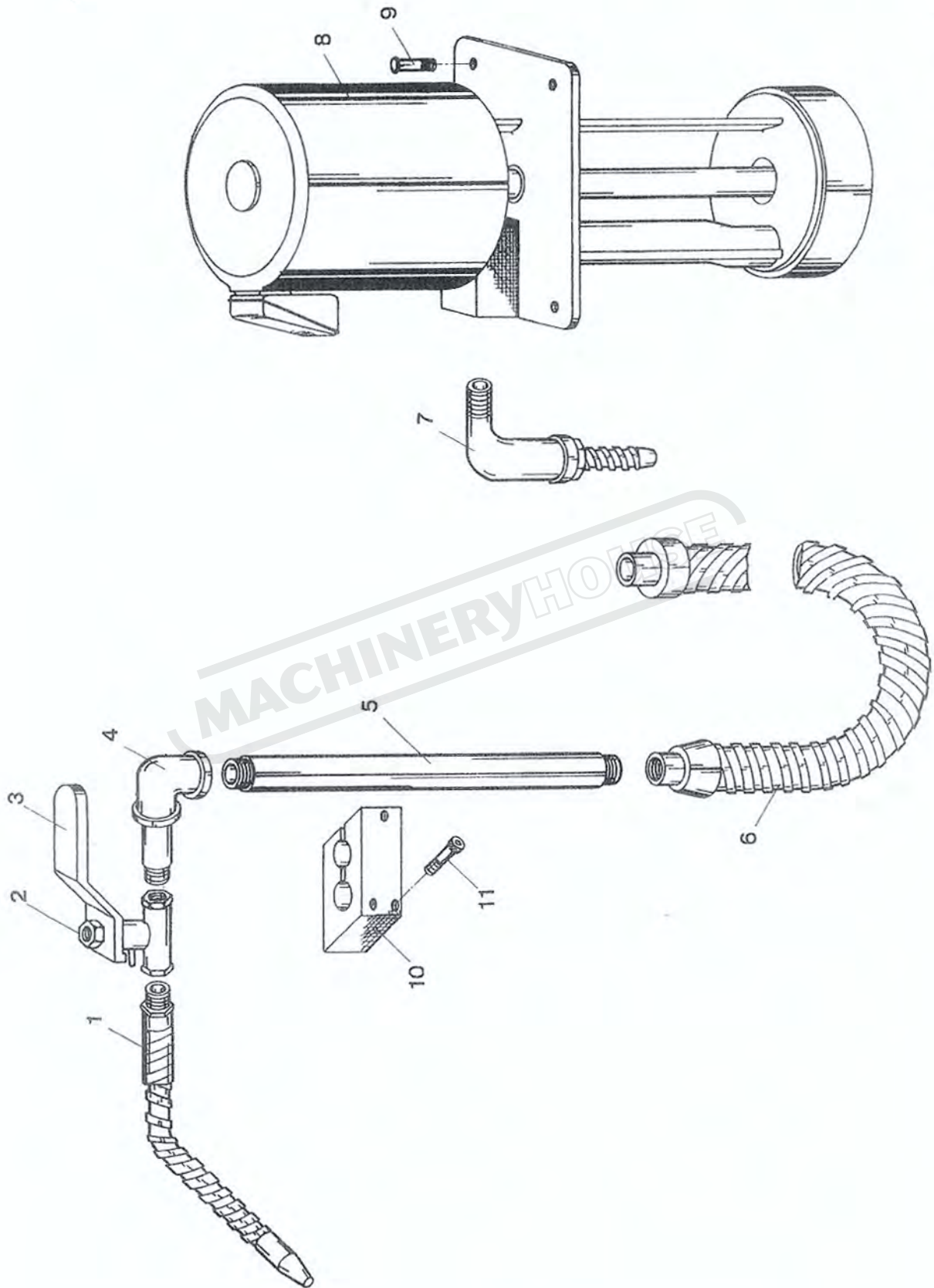

COOLANT SYSTEM ASSEMBLY

Item No.	Part Name	Amt. Used	Type : 16 Part No.	Type : 18 Part No.	Type : 20 Part No.	名稱
1	Nozzle	1				
2	Nut-lock	1				
3	Cock-lever	1				
4	Elbow	1				
5	Pump body	1				
6	Pipe (5, 6 feet)	1	92605002	92605002	92605002	噴水軟管
	(8 feet)	1	92605003	92605003	92605003	
	(10 feet)	1	92605001	92605001	92605001	
7	Elbow	1				
8	Pump body	1				
9	Bolt-hex. head , M6xP1.0x12L	2				
10	Supporter-lock pipe	1				
11	Screw-hexa. socket head cap , M6xP1.10x20L	3	91110620	91110620	91110620	六角承窩螺絲

MACHINERYHOUSE